



M121/M84

Multi-Function Unit

Installation and Operation Manual

NORTHSTAR ★

www.northstarnav.com

Contents

1 Introduction	5
1-1 Overview	6
1-2 Cleaning and maintenance	6
1-3 Plug-in cards	7
1-4 Removing and replacing the display unit	8
2 Basic Operation	9
2-1 Using the keys	11
2-2 Turning on and off / auto power	12
2-3 Backlight and night mode	12
2-4 Man overboard (MOB).....	13
2-5 Alarms.....	13
2-6 Simulate mode.....	14
2-7 The main windows	14
3 Navigation: Chart	19
3-1 Introduction to navigating.....	19
3-2 Chart window	21
3-3 Distance and bearing calculator	23
3-4 Projected course	24
3-5 Tracks and tracking.....	24
4 Video window	25
5 Navigation: Highway window	26
6 Navigation: Waypoints	26
6-1 Waypoints window	27
6-2 Managing waypoints	27
7 Navigation: Routes	29
7-1 Routes window	29
7-2 Managing routes	29
8 Satellites	32
8-1 Satellite window.....	33
9 Sonar fishfinding: Introduction	33
9-1 Using the Instrument	33
9-2 Interpreting the display.....	34
9-3 Single and Dual frequency fishfinding.....	36
9-4 Fish detection and display.....	39
9-5 Range	40
9-6 Gain and threshold	41

10 Sonar fishfinding: Windows	42
10-1 Sonar history window - no split	42
10-2 Sonar Zoom and Full Screen Zoom displays	43
10-3 Sonar Bottom window	44
10-4 Sonar 50/200 window	44
10-5 Sonar A-Scope window	45
11 Gauges window	46
12 Data window	46
13 Fuel functions and display	47
13-1 What the fuel computer does	47
13-2 Fuel display	47
13-3 When you add or remove fuel	48
13-4 Low fuel alarm	49
13-5 Boat speed sensors	49
13-6 Fuel consumption curves	51
13-7 Calibration	53
14 Tides window	54
15 User card window	55
16 AIS	57
16-1 Viewing AIS Vessels	57
16-2 Dangerous Vessels	58
16-3 AIS Windows	58
17 DSC/Buddy track windows	60
17-1 The windows	60
17-2 Using the windows	61
18 Radar	62
18-1 Radar window	62
18-2 Radar modes	63
18-3 Enabling the radar functionality	63
18-4 Selecting standby mode or transmit mode	63
18-5 Disabling the radar functionality	63
18-6 Adjusting the quality of the radar window	63
18-7 Changing the echo expansion setting	65
18-8 Turning the target trails on or off	66
18-9 Using the VRM/EBL	66
18-10 Changing the PPI position	68
18-11 Using the radar guard zones	68

19 Setting up the M121/M84	70
19-1 Setup > System	71
19-2 Setup > Chart	72
19-3 Setup > Sonar	75
19-4 Setup > Radar	76
19-5 Setup > GPS	79
19-6 Setup > Fuel	80
19-7 Setup > Track	81
19-8 Setup > AIS	82
19-9 Setup > Logs	83
19-10 Setup > Alarms	84
19-11 Setup > Units	85
19-12 Setup > Comms	85
19-13 Setup > Calibrate	86
19-14 Setup > Time	87
19-15 Setup > Favorites	88
19-16 Setup > Simulate	88
20 Installation	89
20-1 Installation: What else comes with my M121/M84?	90
20-2 Installation: Options and Accessories	91
20-3 Installation: The display unit	92
20-4 Installation: Power/data cable	94
20-5 Installation: GPS antenna	95
20-6 Installation: Sonar transducer	96
20-7 Installation: Northstar petrol/gasoline sensors	96
20-8 Installation: SmartCraft	97
20-9 Installation: Radar	97
20-10 Installation: Other NavBus instruments	98
20-11 Installation: Other NMEA instruments	99
20-12 Installation: Setup and test	99
Appendix A - Specifications	100
Appendix B - Troubleshooting	103
B-1 General problems	103
B-2 GPS navigation problems	104
B-3 Fuel consumption problems	104
B-4 Sonar fishfinding problems	105
B-5 Radar problems	107
Appendix C Glossary and navigation data	108
Appendix D Compliance statements	111

Warning

It is your sole responsibility to install and use the instrument and transducer(s) in a manner that will not cause accidents, personal injury or property damage. Always observe safe boating practices.

The choice, location, and installation of transducers and other components of the system are critical to the performance of the system as intended. If in doubt, consult your Northstar dealer.

To reduce the risk of misusing or misinterpreting this instrument, you must read and understand all aspects of this Installation and Operation Manual. We also recommend that you practice all operations using the built-in simulator before using this instrument at sea.

Global Positioning System: The Global Positioning System (GPS) is operated by the US Government which is solely responsible for its operation, accuracy and maintenance. The GPS is subject to changes which could affect the accuracy and performance of all GPS equipment anywhere in the world, including this instrument.

Electronic Chart: The electronic chart used by this instrument is an aid to navigation designed to supplement, not replace, official government charts. Only official government charts supplemented by notices to mariners contain the information required for safe and prudent navigation. Always supplement the electronic information provided by this instrument with other plotting sources such as observations, depth soundings, radar and hand compass bearings. Should the information not agree, the discrepancy must be resolved before proceeding any further.

AIS: The AIS features on this chart-plotter are designed as a safety aid only and do not guarantee safety at sea. AIS transmission is mandatory on some, but not all, vessels. You should check your local laws and regulations for requirements in your area. As a result of different legal requirements, different vessel sizes and uses, you should not assume that your AIS equipped chart-plotter will show the location of ALL vessels in your area. Careful prudence, judgement, and safe navigation practices should always be exercised. AIS should be used to complement radar, but AIS is not a substitute for radar.

Sonar performance: The accuracy of the sonar depth display can be affected by many factors, including the type and location of the transducer and water conditions. Never use this instrument to gauge depth or other conditions for swimming or diving.

Fuel data: Do not rely on this instrument as the sole source of information about fuel available onboard. You must supplement this instrument's fuel data with visual or other checks of the fuel available. This is necessary because possible operator errors, such as forgetting to reset the fuel used when filling the tank or running the engine with this instrument not switched on, can render this instrument inaccurate. Fuel economy can change drastically depending on boat loading and sea conditions. Always carry adequate fuel onboard for the intended trip, plus a reserve to allow for unforeseen circumstances.

Simulate mode: Never have simulate mode on when you are navigating on the water.

Failure to adhere to these warnings may lead to death, serious injury or property damage. Northstar disclaims all liability for installation or use of this product that causes or contributes to death, injury or property damage or that violates any law.

1 Introduction

Quick reference to the built-in and optional features:

Feature	Type	See	Requires
General	How to use the keys and windows	2	
	Troubleshooting	Appendix B	
	Simulate mode	2-6	
	Glossary of special names	Appendix C	
	Specifications	Appendix A	
MOB	Man overboard key	2-4	
Navigation	Overview of how to navigate	3-1	GPS fix
	Finding the boat's position on the chart	3-2	
	Navigate to any point or to a waypoint	3-1	
	Navigate along a route	3-1	
	Projected course: An estimate of progress	3-4	
	Tracks: records of where the boat has been	3-5	
	GPS receiver status	8-1	
Saving and loading data with a user card	15	User card	
Chart data	Chart features (built in world chart)	3-2	
	Chart details	3-2-4 & 5	Chart card
	Tides at a port	14	Chart card
	AIS	16	
Alarms	Built in alarms	2-5	
Boat data	Data at top of main displays	2-7-3	
	Compass at top of main displays	2-7-4	
	Dedicated data display	12	
Fuel	Fuel computer, Instrument petrol/gasoline engine	13	Fuel sensors
	Fuel computer, SmartCraft engines	13	SmartCraft
	What to do when you add or remove fuel	13-1	
Sounder	Overview of the depth sounder	9	Sounder
	Depth, bottom features, water features	9	Sounder
	Fishfinder	9	Sounder
Other boats	Track your buddy, polling other boats	17	DSC VHF
	Distress calls	17	DSC VHF

(Continued next page)

Radar	Overview of the radar	18	Radar
	The radar window explained	18-1	Radar
	Change the radar operation mode	18-2	Radar
	Change the radar rotation or motion mode	18-6, 18-7	Radar
	Optimize the quality of the radar window	18-9	Radar
	Find range and bearing with VRM/EBL	18-10	Radar
	Set up the radar guard zones	18-12	Radar

1-1 Overview

The Northstar M121/M84 is a rugged, highly integrated marine chartplotter and fishfinder. It is easy to use and has a high resolution color display. Complex functions can be performed with only a few key presses, taking the hard work out of boating.

The available functions depend on the optional sensors and instruments that are installed:

- The Video window requires the M121/M84 to receive video from a compatible source, such as a camera.
- Fuel functions require one or more petrol/gasoline or diesel fuel sensors to be installed.
- SmartCraft engine functions require a SmartCraft system to be installed. For information on using SmartCraft, see the SmartCraft Gateway Installation and Operation Manual.
- DSC/Buddy track functions require an appropriate Northstar DSC VHF radio to be installed.

- The M121/M84 can send data to other instruments, such as an autopilot, and receive data from other instruments.
- Radar functions require an optional Northstar radar system to be installed. Three radar systems are available; 2 kW, 4 kW, or 6 kW.
- AIS functions require an optional AIS receiver to be installed.

For information on installation options, see section 20.

This manual describes how to install and operate the M121/M84. Special terms are explained in Appendix C. For more information on this instrument and other Northstar products, go to our website, www.northstarnav.com.

1-2 Cleaning and maintenance

The Instrument screen is covered by a proprietary anti-reflection coating. To avoid damage, clean the screen only with a damp cloth and mild detergent when dirty or covered in sea salt. Avoid abrasive cleaners, petrol or other solvents. If a plug-in card gets dirty or wet, clean it with a damp cloth or mild detergent.

Cover or remove a transom-mounted transducer when repainting the hull. If painting over a through hull transducer with antifouling

paint, use only one coat of paint. Remove the previous coat of antifouling paint by sanding it lightly.

To optimize performance, avoid walking on or jamming cables and connectors. Keep the transducer free of weed, paint and debris. Do not use a high pressure water blast on a speed sensor paddlewheel as it may damage the bearings.

Push the dust cover over the display when the Instrument is turned off.

1-3 Plug-in cards

The M121/M84 can use two kinds of C-MAP™ SD-Card plug-in cards:

1. Chart cards have chart details required for navigating in a particular region. When you insert a chart card, the extra details automatically appear on the Chart window. You can plug in up to two chart cards at once. If the chart shows a region not covered by a chart card, then it displays a simplified built-in world chart.
2. User cards store navigation data. A user card allows navigation data to be transferred to another compatible instrument (see section 15).

CAUTION

Handle plug-in cards carefully. Keep them in their protective cases when not plugged into the M121/M84.

Keep the M121/M84 card cover closed at all times to prevent moisture from entering the card compartment.

Removing a plug-in card



Turn the M121/M84 off (see section 2-2). Open the card cover on the right of the display.

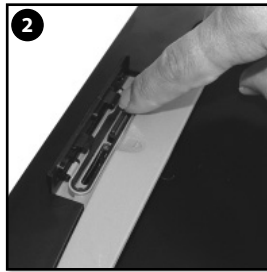

Push the card down until it releases and can pop up.

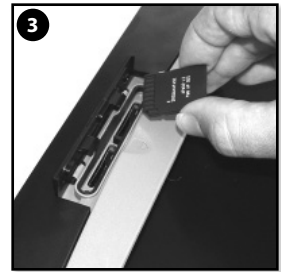

Lift the card out. Put the card in its case.

Inserting a plug-in card

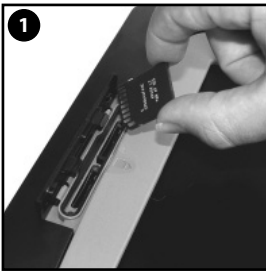

Hold the new card with the gold contacts on the far side.

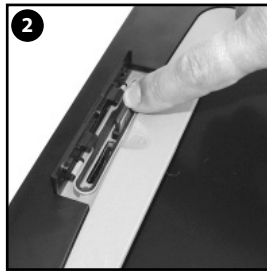

Push the card into an empty socket until it clicks.

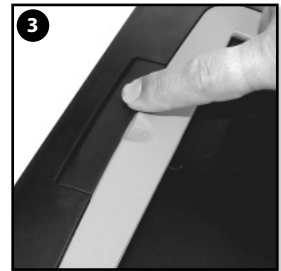

Close the card cover. Turn the M121/M84 on (see section 2-2).

1-4 Removing and replacing the display unit

If the M121/M84 is bracket mounted then it can easily be removed for security.

Removing the display unit:

- 1 Turn the M121/M84 off (see section 2-2) and put the dust cover on.
- 2 Loosen the knobs on the mounting bracket and lift the unit off the bracket.
- 3 Unplug the connectors from the M121/M84; turn each locking collar anticlockwise until you can pull the plug out.
- 4 Store the M121/M84 in a dry clean place.

Replacing the display unit

- 1 Plug the connectors into the back of the display unit:
 - Match the connector's color to the socket color.
 - Insert each connector and turn the locking collar clockwise until it is finger tight.

Nothing will be damaged if a cable is plugged into the wrong socket by mistake.



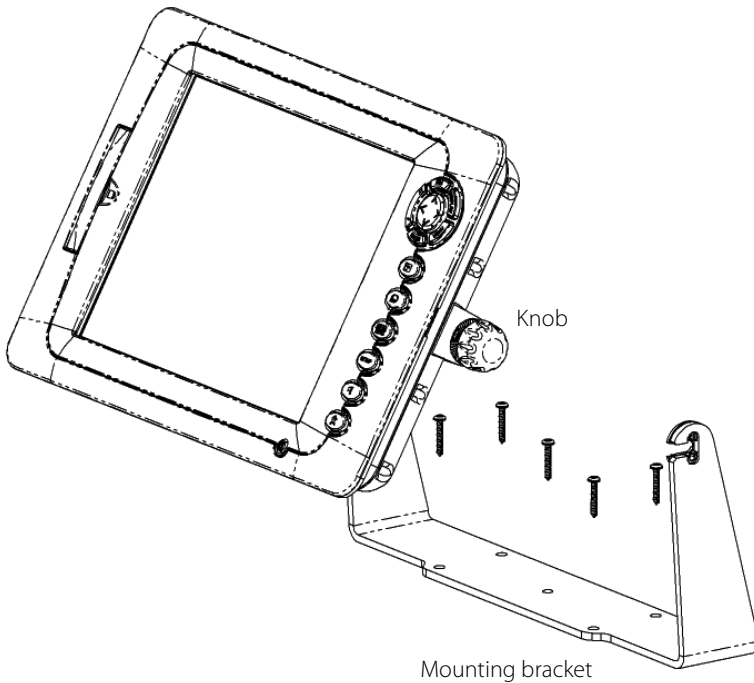



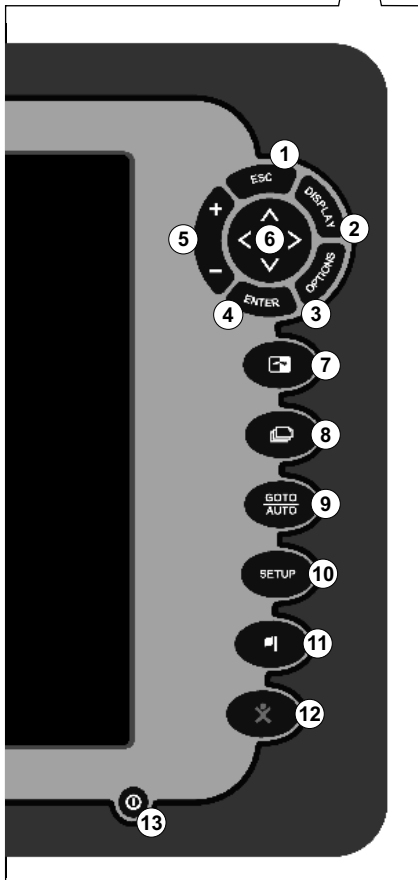

- 2 Hold the M121/M84 in place on the mounting bracket. Tilt it for best viewing, then hand tighten the knobs on the mounting bracket. Remove the dust cover.



2 Basic Operation

Overview of the M121 keys



- ① **ESC** – Go back to an earlier menu or window. In chart mode centers chart at boat's position.
- ② **DISPLAY** – This is a powerful key that allows you to setup the display the way you want. Main displays can be saved as favorite displays for easy access from the  key.
- ③ **MENU** – Show a menu of the options for the current active window.
- ④ **ENTER** – Start an action or accept a change.
- ⑤ **+/-** – Changes the range on a window eg. Chart or Sonar zooms
- ⑥  – Cursor keys, to move the cursor or the selection highlight.
- ⑦  – The  key selects which window you are working with. The Active window is indicated with a red border.
- ⑧  – The  key allows you to quickly switch between your saved favorite displays.
- ⑨ **GOTO AUTO** – For a navigation display: Start navigating to a point, waypoint or along a route (see section 3-1-2). For sonar display: Select a sonar operating mode (see section 6).
- ⑩ **SETUP** – The setup key takes you to the setup menu which allows advanced configuration of the M121.
- ⑪  – This key places a waypoint on the Active Chart Window.
- ⑫  – Man overboard (MOB, see section 2-4).
- ⑬  – Turn Instrument on and off (see section 2-2); adjust the backlighting (see section 2-3).

Overview of the M84 keys

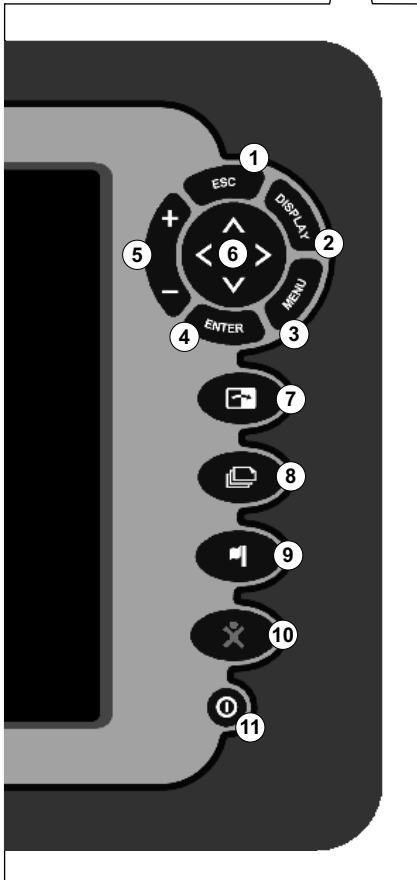

- ① **ESC** – Go back to an earlier menu or window. In chart mode centers chart at boat's position.
- ② **DISPLAY** – This is a powerful key that allows you to setup the display the way you want. Main displays can be saved as favorite displays for easy access from the **MENU** key.
- ③ **MENU** – Show a menu of the options for the current active window. The setup menu can be opened by pressing **MENU** twice.
- ④ **ENTER** – Start an action or accept a change.
- ⑤ **+/-** – Changes the range on a window eg. Chart or Sonar zooms
- ⑥ **←, →, ↑, ↓** – Cursor keys, to move the cursor or the selection highlight.
- ⑦ **📌** – The **📌** key selects which window you are working with. The Active window is indicated with a red border.
- ⑧ **📁** – The **📁** key allows you to quickly switch between your saved favorite displays.
- ⑨ **📍** – This key places a waypoint on the Active Chart Window.
- ⑩ **⚠** – Man overboard (MOB, see section 2-4).
- ⑪ **🔦** – Turn Instrument on and off (see section 2-2); adjust the backlighting (see section 2-3).

Note: **Display** refers to ALL windows and the data header/Compass
Window refers to a part of the display in which a particular function is shown
 e.g. The Chart window on a Chart + Sonar display.

2-1 Using the keys

In this manual:

Press means to push the key for less than a second.

Hold means to hold the key down.

The internal beeper beeps when a key is pressed (to adjust the beep volume, see section 19-1).

Using the menus

Operate the Instrument by selecting items from menus. Items can be submenus, commands or data.

Selecting a submenu

A ▶ after a menu item indicates a submenu, for example Chart ▶. Press ▲ or ▼ to move the highlight to the submenu, then press **ENTER**.

Starting a command

Press ▲ or ▼ to move the highlight to the command, for example Goto cursor, then press **ENTER**.

Palette	Normal
	Normal
	Sunlight
	Night

Changing data

First press ▲ or ▼ to move the highlight to the data to change, then:

a) To change a tick box

means On or Yes

means Off or No.

Press **ENTER** or ▶ to change the tick box.

b) To select an option

1 Press **ENTER** to display the list of options.

2 Press ▲ or ▼ to move the highlight to the option you want, then press **ENTER**.

c) To change a name or number:

1 Press **ENTER** to display the name or number:



2 Press ◀ or ▶ to select a letter or digit to change. Press ▲ or ▼ to change the letter or digit.

Repeat this to change other letters or numbers.

3 Press **ENTER** to accept the new value. Or press **ESC** to ignore the changes.

d) To change a slider value

Press ◀ to decrease the value or ▶ to increase the value.



2-2 Turning on and off / auto power

Turning on manually

If the Instrument is not wired for auto power, press **⏻** to turn the unit on. If necessary, adjust the display to be easy to read (see section 2-3).

WARNING

If the Instrument is not wired for auto power then the Instrument does not record engine hours and will not record fuel consumption if not powered (see section 18-4).

Turning off manually

If the Instrument is not wired for auto power or if the ignition switch is off, hold down **⏻** until the display turns off.

2-3 Backlight and night mode

To go to the Backlight window, press **⏻** briefly.

Backlight

The display and keys are backlit. To change the backlight level, select Backlight, then press **⏻** to dim or **➡** to brighten.

When you have finished, press **ESC**.

Tip: Press **⏻** twice to give the brightest screen, with maximum backlight and Night mode off.

Auto power

If the Instrument is wired for auto power (see section 20-4), then:

- The Instrument automatically turns on when you turn the boat's ignition switch on.
- You can not turn the Instrument off while the ignition switch is on.
- If Auto power off (see section 19-1) is , the Instrument automatically turns off when you turn the boat's ignition switch off.
- If Auto power off (see section 19-1) is , the Instrument stays on when you turn the boat's ignition switch off. You can now turn the Instrument off manually.

Night mode

Night mode sets the palette for all windows.

- Normal palette, for daytime
- A palette optimized for night time.

To change mode, highlight Night mode, then press **➡** or **ENTER**. To change only the chart palette, see section 19-1.

2-4 Man overboard (MOB)

The MOB feature saves the boat's position and then navigates back to this point.

WARNING

MOB will not work if the Instrument does not have a GPS fix.

- 1 Press 
The Instrument stores the boat's position as a waypoint called MOB.
- 2 The Instrument changes to the chart window, with the MOB waypoint at the centre of the chart.
The chart zooms in for accurate navigation. If the chart can not show the required small scale, the Instrument changes to plotter mode (a white window with crosshatching and no chart details, see section 19-2).
- 3 The Instrument sets the MOB waypoint to be the destination to navigate to.

If the NMEA output (autopilot) is off (see section 19-12) use the Instrument to manually navigate to the destination MOB waypoint (see sections 3-1-1 and 3-1-2).

If the NMEA output (autopilot) is on, the Instrument asks if the autopilot is active.

Select:

No: Use the Instrument to manually navigate to the destination MOB waypoint (see sections 3-1-1 and 3-1-2).

Yes: The Instrument asks if the boat is to go to the MOB waypoint.

Select:

Yes: to immediately start navigating to the MOB waypoint.

WARNING

This might result in a sudden and dangerous turn.

No: disengage the autopilot; then use the Instrument to manually navigate to the destination MOB waypoint (see sections 3-1-1 and 3-1-2).

To cancel MOB or set another MOB

- 1 Press  again to display a menu.
- 2 Select an option from the menu.

 **Tip:** The MOB waypoint remains on the chart after the MOB has been cancelled. To delete the MOB waypoint, see section 6-2-5.

2-5 Alarms

When the Instrument detects an alarm condition, it displays a warning message on the display, the internal beeper sounds and any external beepers or lights operate.

Press  to clear the alarm. The alarm will sound again if the alarm condition occurs again. The Instrument has user settable alarms (see section 19-10).

2-6 Simulate mode

In Simulate mode, the Instrument ignores data from the GPS antenna and other transducers and sensors and the Instrument generates this data itself. Otherwise, the Instrument functions normally.

There are two simulate modes:

- Normal: Allows a user to become familiar with the Instrument off the water.
- Demo: Simulates a boat moving along a route and automatically displays different Instrument functions.

To start and stop Simulate mode, and for more information, see section 19-16. In simulate mode, Simulate or Demo flashes at the bottom of the window.



WARNING
Never have Simulate mode on when using the Instrument to navigate on the water.

2-7 The main windows

To show one of the main windows full-size, press **DISPLAY** and select the window.

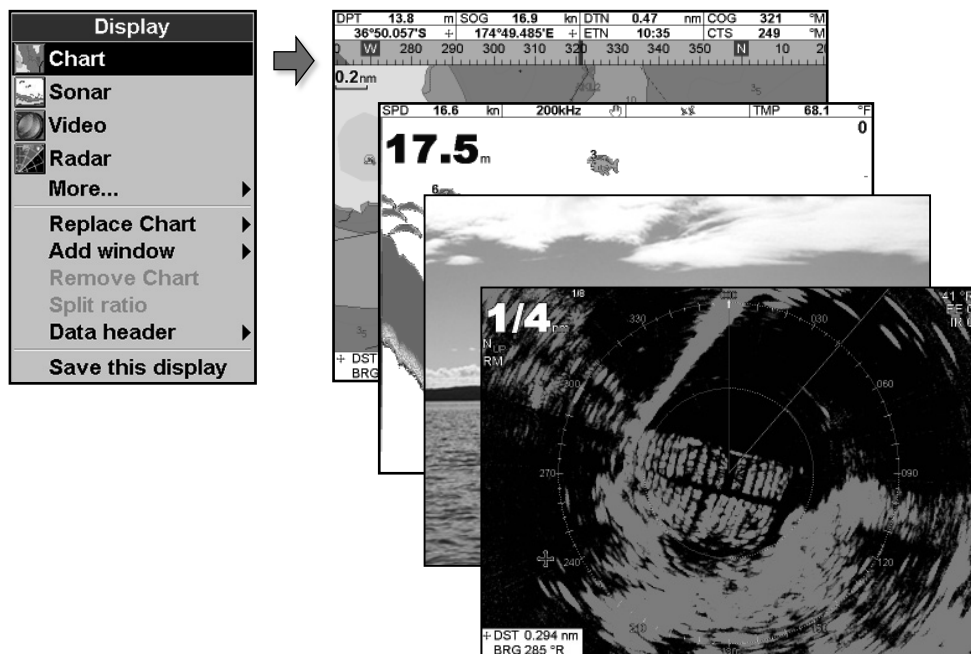

Note

- 1 The windows available depend on the optional sensors and instruments that are installed (see section 1-1).
- 2 Set up commonly used windows as favorites and press **DISP** to switch between windows (see section 2-7-2).

To show one of the other windows full-screen, press **DISPLAY**, select **More...** and select the window.

Press **ESC** to return from one of these windows to the previous window.

Name	Latitude	Longitude	DST(nm)	BRG(M)	Dgr	Disp
AKL0	36°50.328'S	174°40.466'E	7953	116	No	In
AKL1	36°49.849'S	174°40.021'E	7956	116	No	In
AKL2	36°49.079'S	174°40.699'E	7857	116	No	In
AKL3	36°47.849'S	174°40.200'E	7658	116	No	In
AKL4	36°46.974'S	174°40.081'E	7659	116	No	In

Name	Start	End	Legs	DST(nm)
AKLDEMO	AKL0	AKL4	4	2.23
AMSDEMO	AMS0	AMS3	3	6.45
CAEDEMO	CAE0	CAE4	4	6.22
CPTDEMO	CPT0	CPT4	4	11.1
GOADEMO	GOA0	GOA4	4	4.83

Fault details	Engine fault history	Level
1) Guardian engine power limited	Stbd engine limited to 0%	!
2) Reserve oil level low	Stbd engine 0% Remaining	!
3) Reserve oil level low	Port engine 0% Remaining	!
4) Remote oil level low	Port engine	!
5) RPM over speed	Port engine	!
6) Engine voltage high	Stbd engine	!
7) Engine voltage low	Port engine	!
8) Oil pressure low	Stbd engine	!
9) Water pressure low	Stbd engine	!
10) Engine overheating	Stbd engine	!

2-7-1 Multi window displays

The M121/M84 can show up to four windows at once, for example Chart, Sonar, Gauges and Video:



Adding a window to the display

Press **DISPLAY**, select **Add window** and select a window to add. The M121/M84 automatically rearranges the display to show the new window.

Changing window size

- 1 Press **DISPLAY** and select **Split ratio**.
- 2 Press **←** or **→** to change the width of the windows. If the M121/M84 is displaying three or four windows, press **▲** or **▼** to change the height of the windows.

Note: Some windows are fixed in size.

- 3 Press **ENTER**.

Deleting a window from the display

- 1 Press **☒** until the window you want to delete has a red border.
- 2 Press **DISPLAY** and select **Delete window**.

Exchanging two windows on the display

- 1 Press **☒** until the first window has a red border.
- 2 Press **DISPLAY**, select **Replace** and select the second window.

The M121/M84 exchanges the two windows.

Replacing a window on the display

- 1 Press **☒** until the window that you want to replace has a red border.
- 2 Press **DISPLAY**, select **Replace** and select a new window that is not currently visible.

Note

- 1 When some windows are small then not all the data is shown.
- 2 Set up commonly used displays as favorites and press **☒** to switch between displays (see section 2-7-2).

The active window

If there is more than one window displayed, the active window is indicated by a red border. To change the active window to the next window, press **☒**.

Pressing **MENU** will display the options menu for the active window.

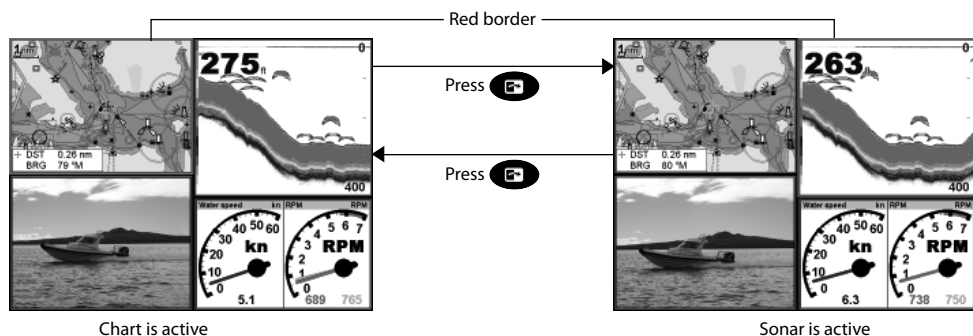

2-7-2 Favorite displays

The M121/M84 has a list of commonly used displays, called favorite displays. There can be up to six favorite displays.

Each display can have one or more windows plus a data header (see section 2-7-3) and a compass (see section 2-7-4). Set up favorite displays for common situations, for example navigating along a route, travelling in a harbour, fishing.

Selecting a favorite display

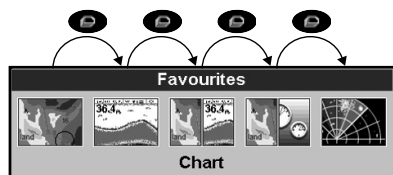

To select another favorite, press **DISPLAY** one or more times. For example, with six favorites:

Adding a favorite display to the list

- 1 Set up the display with the window or windows you want in the new favorite (see sections 2-7-1 and 2-7-4).
- 2 Press **DISPLAY** and select Save this display. The M121/M84 displays the favorites list.

- 3 Select where in the list to add the new favorite. If you select an existing favorite display then the new favorite will replace the existing favorite in the list.

Favourites	
Name	
1	Chart
2	Sonar
3	Chart + Sonar
4	Chart + Gauges
5	Radar
6	-
ENTER to save	

Deleting a favorite display from the list

- 1 Press **MENU** twice then select Favorites.
- 2 Highlight the display to delete, press **MENU** and select Delete.

Changing the order of the favorites list

- 1 Press **MENU** twice then select Favorites.
- 2 Highlight the display to move, press **MENU** and select Move up or Move down.

2-7-3 Data header

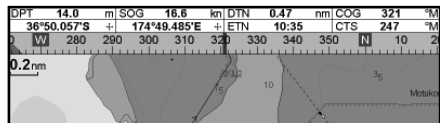

The displays can show data at the top, called the data header.



When you select a window from the display menu (see section 2-7) the M121/M84 displays an appropriate data header for the window.

Each favorite display (see section 2-7-2) has its own data header. When you press  to recall a favorite display, the M121/M84 recalls the favorite displays data header.

Setting the data header for a display

- 1 Press  and select Data header.
- 2 To turn the data header on or off:
 - i Select Data.
 - ii Select or .
- 3 To select the size of the data:
 - i Select Size.
 - ii Select the size to display.
- 4 To change the data displayed:
 - i Select Data setup.
 - ii Change a data field:
 - a Press the cursor keys to highlight the field.
 - b Press  to display a menu of data items.
 - c Select a data item that is available on your system or select None to leave the field empty.
 - iii Repeat the above step to set the other data fields.

 **Tip:** If all fields in a line are None then the line will not be displayed and the data header will take less space on the display.

- 5 Press .

 **Tip:** The data header will change when you select another display. To set a data header that you can recall later, set the header as part of a favorites display (see below).

Favorites displays and data headers

To set a data header for a favorites display, follow the steps to add a favorite (see section 2-7-2 - Adding a favorite display to the list). In step 1, set the data header for the favorite as described above.

2-7-4 Compass

The chart, sonar and highway displays can show a compass at the top of the window.

The compass always shows the boat's course over ground (COG), a black symbol in the middle. When the boat is navigating to a point, the compass also shows bearing to the destination (BRG), a red symbol.

In this example, BRG is 260°M and COG is 321°M.

To turn the compass off or on:

- 1 Press  and select Data header.
- 2 Set Compass to or .

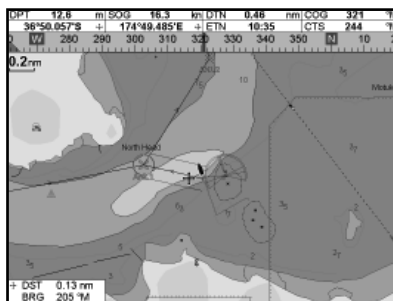

3 Navigation: Chart

The chart window shows the chart, the boat's position course and navigation data.

3-1 Introduction to navigating

The Instrument has two ways of navigating, going straight to a point or following a route.

3-1-1 Navigating to a point

When the Instrument is navigating to a point, the chart and highway windows show navigation data:

- A The boat position ▲
- B The destination point marked with a circle.
- C The boat's plotted course to the destination.
- D Two CDI lines, parallel to the boat's plotted course, which indicate the maximum expected deviation from the plotted course.

For more information, see Appendix C.

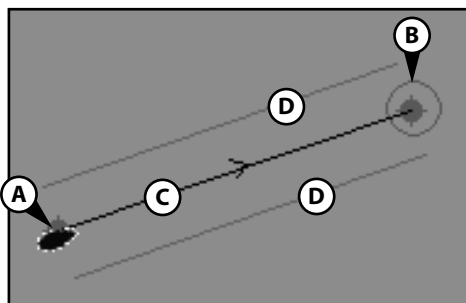

If the Instrument is connected to an autopilot, the Instrument will send data to the autopilot to steer the boat to the destination. Start the autopilot before starting to navigate to the point.

If the Instrument has no autopilot, steer the boat manually:

- a use the boat position and destination on the chart or highway windows
- b or use navigation data displayed on the data header (see section 2-7-3)
- c or use COG and BRG on the compass (see section 2-7-4).

Note:

- 1 If the XTE alarm is enabled, an alarm will sound if the boat deviates too much from its intended course (see section 19-10).
- 2 If the arrival radius alarm is enabled, then an alarm will sound to show that the boat has reached the destination (see section 19-10).
- 3 When the destination is reached an arrival warning appears with the option to cancel navigation (goto or route). Yes the navigation is cancelled, no navigation continues however XTE and highway are no longer displayed.

3-1-2 Going to a waypoint or to a point on the chart

A waypoint is a position that you can set on the Instrument chart, for example a fishing spot or a point on a route (see section 6).

Going to a waypoint from the chart window

- 1 Go to the chart window.
- 2 Move the cursor to the waypoint: either use the cursor keys or use Find (see section 3-2-5).
- 3 Press **MENU** and select **Goto waypoint**.

Going to a waypoint from the waypoints window

- 1 Go to the waypoints window.
- 2 Press **▲** or **▼** to highlight the waypoint to go to.
- 3 Press **MENU** and select **Go to**.

Going to a point on the chart

- 1 Switch to a chart window.
- 2 Move the cursor to the destination point: either use the cursor keys or use Find (see section 3-2-5).
- 3 Press  and select `Goto` cursor.

WARNING

Make sure the course does not pass over land or dangerous waters.

Navigating

The Instrument navigates to the point as described in section 3-1-1.

Cancelling navigating

Go to a Chart window, press  and select `Cancel goto`.

 **Tip:** Before starting, create waypoints at points of interest. Create a waypoint at the start of the trip for you to navigate back to (see section 5-2-1).





3-1-3 Following a route

Preparing

A route is a list of waypoints that the boat can follow (see section 6).

- To create waypoints before creating the route, see section 6-2-1.
- To create a route, see section 6-2-1.

Starting a route from the chart window:

- 1 Go to the chart window.
- 2 Press  and select `Start Route`
- 3 Press  or  to highlight the route to follow. Press .
- 4 The Instrument asks for the direction to traverse the route. Select `Forward` (the order the route was created) or `Reverse`.
- 5 The Instrument displays the chart with the route marked and starts navigating from the start of the route.

Starting a route from the routes window:

- 1 Go to the routes window.
- 2 Then follow step 3 as in **starting a route from the chart window** above.

Navigating

The Instrument navigates to each waypoint on the route in turn as described in section 3-1-1.

The Instrument stops navigating to the waypoint at the end of the current leg and starts the next leg of the route:

- 1 When the boat comes within 0.025 nm of the waypoint
- 2 Or when the boat passes the waypoint
- 3 Or if you skip the waypoint.

Skipping a waypoint

To skip a waypoint, go to a chart window, press  and select `Skip`. The Instrument starts navigating straight towards the next waypoint on the route.

CAUTION

Skipping a waypoint with the autopilot on might result in a sudden course change.

Cancelling a route

When the boat has reached the final waypoint, or to stop the boat following the route at any time, cancel the route. Go to a chart window, press  and select `Cancel route`.

3-2 Chart window

To go to the Chart window:

- Press **DISPLAY** and select Chart

A typical chart window shows:

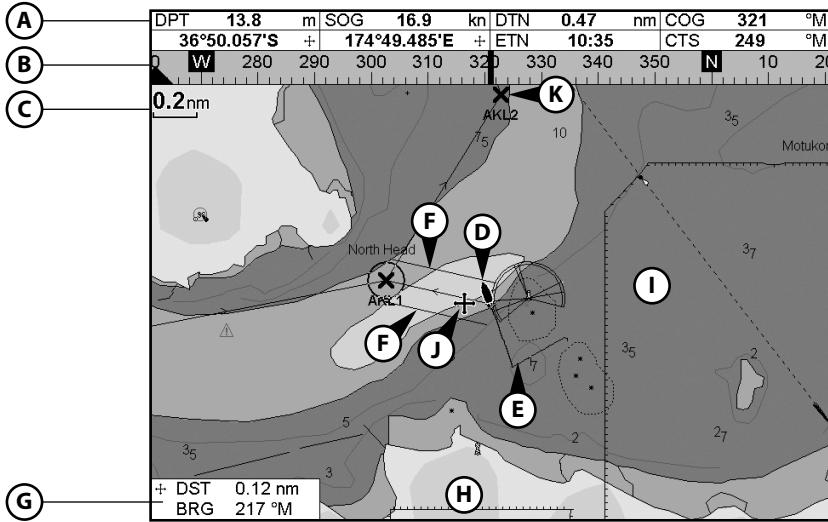

- A** Data header. To turn the data off or on or to change what data is displayed (see section 2-7-3)
- B** Compass (see section 2-7-4)
- C** Chart scale (see section 3-2-3)
- D** Boat position (see section 3-2-1)
- E** Boat track (see section 3-5)
- F** Boat course and CDI lines (see Appendix C, CDI).
- G** Distance and bearing of cursor from boat
- H** Land
- I** Sea
- J** The cursor (see section 3-2-1)
- K** A typical waypoint (see section 6)

Note:

To change the types of information displayed on the chart, see section 17-2.

To change to a perspective view of the chart, see section 3-2-6.

If the region on the chart is covered by a chart card then the card's information is automatically displayed on the chart. If the region is not covered by a chart card then the chart displays a simplified built-in world chart which is suitable for planning and general interest.

WARNING

The built-in world chart does not show enough detail for navigation. When you use the M121/M84 to navigate, always use a chart card which covers the region.





3-2-1 Chart modes

The Chart has two modes:

Centre on boat mode

To switch to centre on boat mode in the chart window, press **ESC**. The boat  is at the centre of the chart. As the boat moves through the water, the chart automatically scrolls to keep the boat in the centre of the chart. The cursor (see below) is turned off.

Cursor mode

The keys , ,  and  are called cursor keys. To switch to cursor mode in the chart window, hold down a cursor key. The cursor  appears and moves away from the boat:

- Press the key which points in the direction that the cursor will move, for example press  to move the cursor down.
- Press midway between two of the cursor keys to make the cursor move diagonally.
- Hold a cursor key down to make the cursor move continuously across the window.

In Cursor mode:

- The distance (**+DST**) and bearing (**+BRG**) of the cursor from the boat are displayed at the bottom corner of the window.
- The chart does not scroll as the boat moves.
- If the cursor reaches the edge of the window, the chart will scroll.

For example, hold down  to move the cursor to the right side of the window and the chart will scroll to the left.

3-2-2 Latitude and longitude

Latitude and longitude can be displayed in the data header. The window is degrees and minutes to three decimal places, about 2 m (6 ft) resolution. Normally the position is the boat's position, and the latitude and longitude has a boat symbol to show this:

 36° 29.637' N or S Latitude

 175° 09.165' E or W Longitude

If the cursor has been moved in the last ten seconds, then the position is the cursor's

position, and the latitude and longitude has a cursor symbol to show this:



 36° 29.841' N or S Latitude

 175° 09.012' E or W Longitude



When reading the boat position, make sure the position is not the cursor position.



3-2-3 Chart scale

Press  to zoom in and display a smaller area of the chart in more detail. Press  to zoom out and display a bigger area in less detail.



The chart scale is displayed at the top left of the chart:







3-2-4 Chart symbols and information

The chart shows many kinds of symbols, such as waypoints, ports, marinas, buoys and beacons. If necessary, press  or  to choose a chart scale where the symbol is displayed.

To see stored information about a symbol:

- 1 Either move the cursor to the symbol on the chart and wait two seconds or use Find to move the cursor to a symbol for a port or service (see section 3-2-5).
- 2 A window appears at the bottom of the display with some information about the symbol.
- 3 To see more detail about a symbol or a list of associated items for the symbol, press **ENTER** :
 - i Select an item to display. If there are more items than will fit on the window, press  or  to scroll up or down.

Select a camera icon to display a photo of the item. If the photo is too big to fit on the window, press , ,  or  to scroll the photo.

Select Tide Station to display a tide chart for the position (see section 14).
 - ii Select other items or press **ESC** to return to the chart.

To see stored information about nearby symbols press **MENU** and select **Chart info**. Then follow step 3 above.

3-2-5 Finding a chart symbol

To find and display a chart symbol:

- 1 Press **MENU** and select **Find**.
- 2 Select the type of symbol: Waypoints, Routes, Ports by name, Ports & services, or Tide stations.
- 3 For Ports & services: select the type of service to find.
For Ports by name: press **▲**, **▼**, **◀** or **▶** to enter a name or letters contained in the port name, then press **ENTER**.
- 4 A list of items is displayed. If there are more items than will fit on the window, press **+** or **-** to page up and down.
For Ports by name: to search for a different port name, press **ESC**. Change the name, then press **ENTER**.
- 5 Select the item and press **ENTER**. The chart window changes to show the item in the middle of the window.
To see stored information about the item, press **ENTER** (see section 3-2-4).

3-2-6 Perspective view

Perspective view shows the chart from an angle instead of from straight above. To turn perspective view on or off, press **MENU** and set **Perspective** to **☑** or **☐**.

3-2-7 Turn the radar overlay on or off

If you have a radar installed, you can overlay the radar screen on your chart screen. This is extremely useful because it can help you to:

- interpret the radar image by matching the radar targets with charted objects
- quickly identify objects that are not on the chart, such as other boats

The radar overlay is also very useful in conditions of reduced visibility, at night, or in busy or hazardous waters.

The range, rotation, mode, and centre position of the radar are all adjusted automatically to match your chart.

To turn the radar overlay on or off:

From the chart window, press **MENU** and set **Radar Overlay** option to **☑** or **☐**.

An extra menu item will then be displayed to control the radar and overlay.

3-3 Distance and bearing calculator

The distance and bearing calculator can plot a course of one or several legs and show the bearing and length of each leg, as well as the total distance along the course. The completed course can be converted into a route.

To use the distance and bearing calculator:

- 1 Select the **Chart** window. Press **MENU** and select **Distance**.
- 2 Move the cursor to the start of the first leg. It does not matter if this point is a waypoint or not. Press **ENTER**.
- 3 To add a leg to the course, move the cursor to the end of the leg. It does not matter if this point is a waypoint or not. The window shows the bearing and length of the leg, as well as the total distance along the course.
Press **ENTER**.
- 4 To remove the last leg from the course, press **MENU** and select **Remove**.
- 5 Repeat the above two steps to enter the whole course.
- 6 To save the new course as a route, press **MENU** and select **Save**. This also saves any new points on the course as new waypoints, with default names. If necessary, edit the route later (see section 6-2-2) and edit any new waypoints later (see section 6-2-3).
- 7 Finally, press **ESC** to return to the chart window.

3-4 Projected course

If Projected course is turned on, then the Instrument will display the projected position based on the course over ground (COG), speed and a specified time. To turn Projected course on and off and to set the time, see section 19-2.

- A Projected position
- B Boat's projected course
- C Boat position

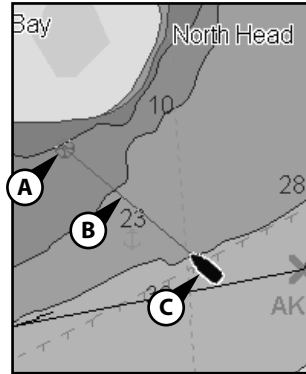

3-5 Tracks and tracking

Tracking records the boat's position to memory at regular intervals, which can be:

- Time intervals.
- Or distance intervals.

The track of where the boat has been can be displayed on the chart. The Instrument can display one track while recording another.

To work with tracks, see section 19-7.

The Instrument can store five tracks:

- Track 1 can hold up to 2000 points and is intended to record the normal progress of the boat.
- Tracks 2, 3, 4 and 5 can hold up to 500 points each and are intended to record sections to be retraced accurately, for example entering a river mouth.

Tip: Record a reference tracks and then use the track to help navigate the same trip later. For example, record a reference track as you leave harbour. Then if you return to harbour and visibility is poor, select the chart and navigate manually along the reference track back into the harbour. Record reference tracks in good conditions.

When recording is on and the track becomes full then recording continues and the oldest points in the track are deleted. The maximum length of a track depends on the selected track interval: a small interval will give a shorter, more detailed track and a long interval will give a longer, less detailed track, as shown in these examples:

Time intervals

Interval	Track 1	Track 2, 3, 4 or 5
1 sec	33 minutes	8 minutes
10 sec	5.5 hours	1.4 hours
1 min	33 hours	8 hours

Distance intervals

Interval	Track 1	Track 2, 3, 4 or 5
0.01	20	5
1	2,000	500
10	20,000	5,000

The track lengths are in the current distance units, for example nm.

4 Video window

The video window shows a picture from a video device, such as a camera. The video window requires a video device to be installed. To select the video window, press **DISPLAY** and select Video.

Adjusting the video picture color

- 1 Press **MENU**.
- 2 Press **▲** or **▼** to highlight a control, then press **◀** or **▶** to adjust the control.
- 3 To return the colors to their default settings, select Restore defaults.
- 4 Press **ESC**.

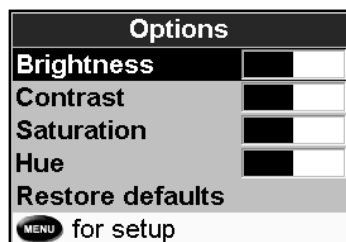

Changing the video picture

Press **+** to zoom in



Press **-** to zoom out



Press **◀** or **▶** to move the picture sideways



Press **▲** or **▼** to move the picture up and down



Press **ESC** to fit the whole picture in the window



5 Navigation: Highway window

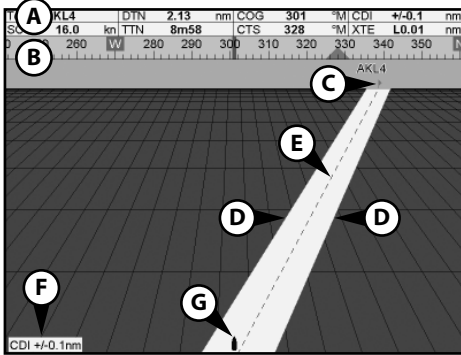

The highway window has a bird's eye view of the boat's course to a destination:

To go to the Highway window, press **DISPLAY**, select **MORE**, then select **Highway**.

The highway window shows:

- A** Optional data header (see section 2-7-3)
- B** Optional compass (see section 2-7-4)
- C** Destination waypoint
- D** Boat's plotted course to destination
- E** CDI lines, parallel to the boat's plotted course (see Appendix C, Navigation data, CDI). The CDI lines are like a highway over the water where the boat will move
- F** CDI scale
- G** The boat position is at the bottom, centre of the window

WARNING

The highway window does not show land, dangerous waters or chart symbols.

6 Navigation: Waypoints

A waypoint is a position that you can set on the Instrument chart, for example a fishing spot or a point on a route. The Instrument can have up to 3000 waypoints. A waypoint can be created, changed or deleted.

A waypoint has:

- A name (up to eight characters).
- An icon showing what kind of waypoint it is.
The available icons are:



- A position.
- A color for the waypoint symbol and name on the chart.
- A type:
 - Normal:** A normal waypoint can be navigated to or included in a route.
 - Danger:** A danger waypoint is a point to avoid. If the boat comes within the danger radius of a danger waypoint the unit can sound an alarm (see section 19-10).
- A display option:
Controls how the waypoint is displayed on the chart (see section 19-2):

6-1 Waypoints window

To go to the waypoints window, press **DISPLAY**, select **More**, then select **Waypoints**.

The waypoints window is a list of the waypoints that have been entered, each with waypoint symbol, name, latitude and longitude, distance and bearing from the boat, type and display option.

If there are more waypoints than will fit on the window, press **+** or **-** to scroll up or down a page at a time.

Waypoints							
Name	Latitude	Longitude	DST(nm)	BRG(°M)	Dngr	Disp	
AKL0	36°50.338'S	174°46.495'E	7653	116	No	H+N	
AKL1	36°49.945'S	174°49.021'E	7656	116	No	H+N	
AKL2	36°49.079'S	174°49.695'E	7657	116	No	H+N	
AKL3	36°47.849'S	174°49.200'E	7658	116	No	H+N	
AKL4	36°46.974'S	174°49.081'E	7658	116	No	H+N	
AMS0	53°19.180'N	007°18.545'E	5257	18	No	H+N	
AMS1	53°19.782'N	007°14.141'E	5258	18	No	H+N	
AMS2	53°19.927'N	007°10.720'E	5259	18	No	H+N	
AMS3	53°19.927'N	007°07.868'E	5259	18	No	H+N	
CAE0	32°46.675'N	079°57.248'W	6849	330	No	H+N	
CAE1	32°46.199'N	079°56.591'W	6848	330	No	H+N	
CAE2	32°46.546'N	079°55.009'W	6846	330	No	H+N	
CAE3	32°46.526'N	079°51.987'W	6844	330	No	H+N	
CAE4	32°44.439'N	079°50.807'W	6843	330	No	H+N	
CPT0	33°53.609'S	018°24.303'E	9.85	233	No	H+N	
CPT1	33°53.036'S	018°28.214'E	8.20	215	No	H+N	
CPT2	33°50.456'S	018°28.098'E	5.70	220	No	H+N	

6-2 Managing waypoints

WARNING

Do not create a navigation waypoint on land or in dangerous water.

6-2-1 Creating a new waypoint

Creating and editing a new waypoint from the chart window

- To create a waypoint at the boat position, press **ESC** to switch the chart to centre on boat mode.
Or, to create a waypoint at a different point, move the cursor to that point on the chart.
- Press **ENTER**.
- A new waypoint, with the default name and data is created.
- Change the waypoint data if necessary (see section 6-2-7).

Creating a new waypoint from the waypoints window

- In the waypoints window, press **MENU** and select **Create**.
- A new waypoint, with a default name and data, is created at the boat position.
- Change the waypoint data if necessary (see section 6-2-7).

Note: Waypoints can also be created when a route is created (see section 6-2-1).

6-2-2 Moving a waypoint

Moving a waypoint from the chart window

- In the chart window, move the cursor to the waypoint to move.
- Press **MENU** and select **Move**.
- Move the cursor to the new position and press **ENTER**.

Moving a waypoint from the waypoints window

To move a waypoint from the waypoints window, edit the waypoint (see section 6-2-3) and change the latitude and longitude.

6-2-3 Editing a waypoint

Editing a waypoint from the chart window

- In the chart window, move the cursor to the waypoint to edit.
- When the waypoint data is displayed, press **ENTER**.
- Change the waypoint data (see section 6-2-7).

Editing a waypoint from the waypoints window

- 1 In the waypoints window, press **▲** or **▼** to highlight the waypoint to edit. Press **MENU** and select **Edit**.
- 2 Change the waypoint data (see section 6-2-7).

6-2-4 Displaying a waypoint on the chart

This goes to the chart window, and shows the selected waypoint at the centre of the window.

- 1 In the waypoints window, press **▲** or **▼** to highlight the waypoint to display. Press **MENU** and select **Display**.
Or, in the Chart window, press **MENU**, select **Find**, then select **Waypoints**. Select a waypoint from the list.
- 2 The Instrument switches to the chart window, with the selected waypoint at the centre of the chart.

6-2-5 Deleting a waypoint

A waypoint can not be deleted if the boat is navigating to it or if the waypoint is used in more than one route. A waypoint that is used in one route can be deleted.

WARNING

When a waypoint is deleted from a route, check that the changed route does not cross land or dangerous waters.

Deleting a waypoint from the chart window

- 1 In the chart window, move the cursor to the waypoint to delete.
- 2 Press **MENU** and select **Delete**.
- 3 Select **Yes** to confirm.

Deleting a waypoint from the waypoints window

- 1 In the waypoints window, press **▲** or **▼** to highlight the waypoint to delete. Press **MENU** and select **Delete**.
- 2 Select **Yes** to confirm.

6-2-6 Deleting all waypoints

- 1 In the waypoints window and press **MENU** and select **Delete all**.
- 2 Select **Yes** to confirm.

6-2-7 Changing a waypoint's data

To change the waypoint data when it is displayed in a window:

- 1 Select the data to change.
Press **ENTER**.
Use the cursor keys to change the data.
Press **ENTER**.
- 2 If necessary, repeat the above step to change other data.
- 3 Select **Save**.

6-2-8 Sort Waypoints

To change how the waypoints list is displayed:

- 1 Press **MENU** and select **Sort by**.
- 2 Select how to display the list:
Name: In alphabetical order by name.
Icon: Grouped by icon type.
Distance: In order of distance from the boat.

An arrow at the top of a column indicates how the waypoints are sorted.

6-2-9 Navigating to a waypoint

See section 3-1-2.

7 Navigation: Routes

A route is a list of waypoints that the boat can navigate along. Routes can be created, changed and deleted.

The Instrument can have up to 25 routes. Each route can have up to 50 waypoints.

A route can:

- Start and stop at the same waypoint .
- Include waypoints more than once.

The Instrument can navigate along a route in either direction. Waypoints on the route can be skipped.

Routes are a powerful feature when the Instrument is connected to an autopilot, allowing the vessel to be automatically guided along the route.



WARNING

Make sure that routes do not cross land or dangerous water.



7-1 Routes window

The routes window is a list of the routes that have been entered, each with route name, start waypoint, end waypoint, number of legs and total distance.

To go to the routes window, press , select **More**, then select **Routes**.

If there are more routes than will fit on the window, press  or  to scroll up or down a page at a time.

Routes				
Name	Start	End	Legs	DST(nm)
AKLDEMO	AKL0	AKL4	4	5.25
AMSDEMO	AMS0	AMS3	3	6.45
CAEDEMO	CAE0	CAE4	4	6.22
CPTDEMO	CPT0	CPT4	4	11.1
GOADEMO	GOA0	GOA4	4	4.83
LRHDEMO	LRH0	LRH4	4	4.56
OSLDEMO	OSL0	OSL5	5	5.05
SFODEMO	SFO0	SFO5	5	3.11
SOUDEMO	SOU0	SOU4	4	3.02
SYDDEMO	SYD0	SYD4	4	4.43

  to page up/down

7-2 Managing routes



WARNING

After creating or changing a route, display the route on the chart and check that it does not cross land or dangerous water.

7-2-1 Creating a new route

A. Creating a new route from the chart window

While creating the route:

- Press  or  to change the range; scroll the chart by moving the cursor to the edge of the chart.

- A data box at the bottom left of the window shows the route name and total distance. If the cursor is near a leg, it shows the length and bearing of the leg as well.
- The legs of a route must start and end at waypoints. If a leg does not start or end at an existing waypoint then a new waypoint will be created automatically (to change the new waypoint data, see section 6-2-1).
- You can not use a Danger waypoint in a route.

- 1 In the chart window, press **MENU** and select New route.
- 2 The route is given a default name:
 - i Change the name if necessary.
 - ii Select OK.
- 3 To enter the legs of the route:
 - i Move the cursor to the start of the route and press **ENTER**.
 - ii A waypoint is created with a default name. To save this waypoint press **ENTER**, to edit the waypoint refer to 6-2-3
 - iii Press **ENTER** a dotted leg line is displayed from the cursor to the previous waypoint
 - iv Move the cursor to the end of the first leg and press **ENTER**.
 - v Repeat i to iv until the last waypoint in the route is placed and saved
 - vi Press **ESC** to complete the route

Menu options while creating a route:

- 1 To add a waypoint to the route
 - i Press **MENU** and select Add.
- 2 To insert a waypoint in the route by breaking one leg into two:
 - i Move the cursor to the leg you want to break.
 - ii Press **MENU** and select Insert.
 - iii Move the cursor to where the new route waypoint will be.
 - iv Press **ENTER**.
- 3 To move a waypoint in the route:
 - i Move the cursor to the waypoint to move.
 - ii Press **MENU** and select Move.
 - iii Move the cursor to where the waypoint will be.
 - iv Press **ENTER**.
- 4 To remove a waypoint from the route:
 - i Move the cursor to the waypoint to remove from the route.

- ii Press **MENU** and select Remove. The waypoint is removed from the route, but the waypoint is not deleted.
- 5 To start navigating the route
 - i Press **MENU** and select Start
- 6 To end creating the route
 - i Press **MENU** and select End
- 7 To delete the route
 - i Press **MENU** and select Delete
 - ii Select yes to confirm.

Tip: The distance and bearing calculator can also be used to enter a course and save it as a route (see section 3-3).

B. Creating a new route from the routes window

- 1 In the routes window, press **MENU** and select Create.
- 2 A new route, with a default name and no waypoints, is displayed.
- 3 To change the route name:
 - i Select the route name at the top of the window and press **ENTER**.
 - ii Change the name if necessary.
 - iii Press **ENTER**.
- 4 To insert a waypoint in the route:
 - i Select where the waypoint will be:
 - To insert the first waypoint in a new route, select Leg 1.
 - To insert a waypoint at the end of the route, select the unused leg at the end of the list of waypoints.
 - Otherwise, select the waypoint to insert the new waypoint in front of.
 - ii Press **ENTER**. A list of waypoints is displayed. Select the waypoint to use. As waypoints are inserted, the distance and bearing of each leg is shown automatically. If the route has more waypoints than will fit on the window, press **▲** or **▼** to see them.

- 5 To remove a waypoint from the route:
 - i Select the waypoint to remove.
 - ii Press **MENU** and select Remove.
- 6 Repeat this process until the route is finished.
- 7 Press **ESC**.
- 8 Display the route on the chart (see section 6-2-3) and check that the route does not cross land or dangerous water.

7-2-2 Editing a route

Editing a route from the chart

- 1 In the routes window, select the route to edit. Press **MENU** and select Edit on chart.
- 2 The selected route is displayed on the chart, with a circle around the first waypoint.
- 3 Edit the route as described in section 6-2-1 A, starting at step 4.

Editing a route from the routes window

- 1 In the routes window, press **▲** or **▼** to highlight the route to edit. Press **MENU** and select Edit.
- 2 The selected route is displayed: the route name and a list of the waypoints.
- 3 Edit the route as described in section 6-2-1 B, starting at step 3.

7-2-3 Displaying a route on the chart

To view the selected route at the centre of the window:

- 1 In the routes window, press **▲** or **▼** to highlight the route to window. Press **MENU** and select Display.
Or, in the Chart window, press **MENU**, select Find, then select Route. Select a route from the list.
- 2 The Instrument displays the selected route on the chart.

7-2-4 Deleting a route

- 1 In the routes window, press **▲** or **▼** to highlight the route to delete. Press **MENU** and select Delete.
- 2 Select Yes to confirm.

7-2-5 Deleting all routes

- 1 In the routes window, press **MENU** and select Delete all.
- 2 Select Yes to confirm.

7-2-6 Navigating a route

See section 3-1-3.

8 Satellites

GPS worldwide navigation

The US Government operates the GPS system. Twenty-four satellites orbit the earth and broadcast position and time signals. The positions of these satellites are constantly changing. The GPS receiver analyses the signals from the closest satellites and calculates exactly where it is on earth. This is called the GPS position.

The accuracy of the GPS position is typically better than 10 m (33 ft) for 95% of the time. A GPS antenna can receive signals from the GPS satellites when it is almost anywhere on earth.

DGPS

A DGPS system uses correction signals to remove some of the errors in the GPS position. The Instrument can use one of two types of DGPS system:

- **WAAS and EGNOS DGPS**

WAAS and EGNOS are two satellite based DGPS systems. The correction signals are broadcast by satellites and are received by the Instrument's standard GPS antenna. The accuracy of the corrected GPS position is typically better than 5 m (15 ft) for 95% of the time.

WAAS covers all of the USA and most of Canada. EGNOS will cover most of Western Europe when it becomes operational.

- **Differential beacon DGPS**

Differential beacons are land based radio transmitters that broadcast correction signals that can be received by a special receiver on the boat. Differential beacons are usually only installed near ports and important waterways, and each beacon has a limited range. The accuracy of the corrected GPS position is typically better than 2 to 5 m (6 to 16 ft).

GPS receiver

Northstar GPS units have a sensitive 12-channel receiver, which tracks signals from all GPS satellites visible above the horizon and uses measurements from all satellites more than 5° above the horizon to calculate the position.

Each time a GPS receiver is turned on, it normally takes about 50 seconds before it outputs the first position. Under some circumstances it will take up to two minutes or longer.

8-1 Satellite window

The satellite window has information about the GPS satellites and GPS position.

To go to the satellite window, press **DISPLAY**, select **More**, then select **Satellite**.

The satellite window shows:

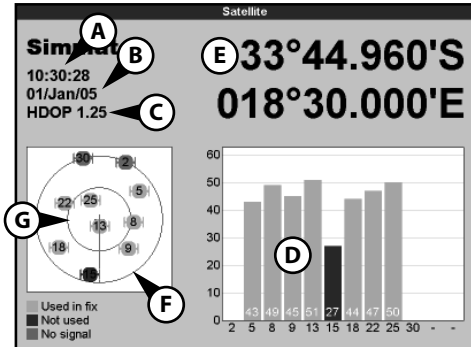

- A** Status of GPS antenna, for example **Acquiring**, **GPS fix**, **No GPS**. If the unit is in **Simulate** mode it displays **Simulate** (see section 2-6).
- B** Time and date from GPS satellites. Time is local time (UTC [GMT] plus local offset, see section 19-4)
- C** HDOP: The error in the GPS position caused by satellite geometry. A low value indicates a more precise fix, a high value a less precise fix
- D** Signal strengths of up to twelve visible GPS satellites. The higher the bar the stronger the signal
- E** Boat position
- F** Positions of visible GPS satellites:
 - Outer circle is horizon
 - Inner circle is 45° elevation
 - Centre is directly above
 - North is at top of window
- G** If the boat is moving, COG is a line from centre

9 Sonar fishfinding: Introduction

Sonar functions require an optional sonar transducer to be installed and set up.

This section explains how to interpret the sonar displays, when and why to use the different frequencies and how fish are detected and displayed.

It also describes Gain and Range and shows examples of some of the different sonar displays.

9-1 Using the Instrument

The Instrument uses a sonar transducer attached to the hull. The transducer generates an ultrasonic pulse (sound that is above the hearing range of the human ear), which travels down towards the bottom at a speed of about 4800 ft/sec (1463 m/sec), spreading out into a cone shape.

When the pulse meets an object, such as a fish or the bottom, it is partly reflected back up towards the boat as an echo.

The depth of the object or bottom is calculated by the Instrument by measuring the time taken between sending a pulse and receiving the echo. When an echo has been returned, the next pulse is sent.

The Instrument converts each echo into an electronic signal, displayed as a vertical line of pixels.

The most recent echo appears on the extreme right of the window, with the older echoes being scrolled towards the left, eventually disappearing off the window.

The scroll speed depends upon the water depth and scroll speed setting. See sections 19-3 and section 9-2, for more information.

The appearance of echoes displayed are affected by:

- The Instrument settings (see sections 19-3, 9-5 and 9-6)
- Echoes (different fish types, different bottom types, wrecks and seaweed; see section 9-2)
- Noise (water clarity and bubbles; see section 9-2).

Cruise, Fishing and Manual Modes

The Instrument has three sonar operating modes:

- **Cruising mode:** Use this when on the move. The Instrument automatically adjusts its settings to compensate for water clarity and to display the bottom.
- **Fishing mode:** Use this when fishing. The Instrument automatically adjusts its settings to compensate for water clarity and to best display fish, the bottom and other details.
- **Manual mode:** Use this to fine-tune the Instrument settings by hand. Best results are often achieved in manual mode, but practice and experience are required to obtain the optimum settings for different conditions.

For more information about modes, see sections 9-5 and 9-6.

⚠ WARNING

Use the automatic Cruising or Fishing modes when learning to use the Instrument or when travelling at speed.

9-2 Interpreting the display

The sonar windows do not show a fixed distance travelled by the boat; rather, they display a history, showing what has passed below the boat during a certain period of time.

The history of the sonar signal displayed depends the depth of the water and the scroll speed setting.

In shallow water, the echoes have a short distance to travel between the bottom and the boat. In deep water, the history moves across the window more slowly because the echoes take longer to travel between the bottom and the boat. For example, when the scroll speed is set to **F**ast, at depths over 1000 ft (300 m) it takes about 2 minutes for the data to move across the window, whereas at 20 ft (6 m) it takes only about 25 seconds.

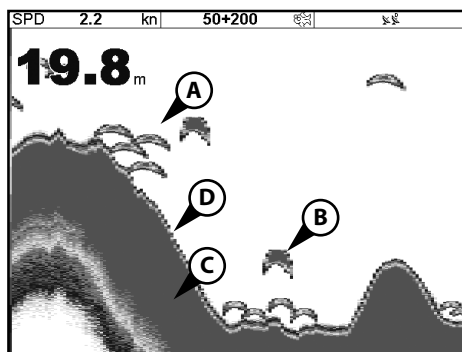

- A** School of fish
- B** Single fish
- C** Hard bottoms such as rock and coral show as wide bands
- D** Soft bottoms such as mud, weed and sand show as narrow bands

The scroll speed can be set by the user to display either a longer history with less fish information or a shorter history with more fish details (see section 19-3).

If the boat is anchored, the echoes all come from the same area of bottom. This produces a flat bottom trace on the window.

The screen shot shows a typical sonar window with the Fish symbols turned OFF. The sonar pulse generated by the Instrument transducer travels down through the water, spreading outwards in a cone shape. The cone width is dependent upon the frequency of the pulse; at 50 kHz it is approximately 45°, and at 200 kHz it is approximately 11°.

The differences in the cone width affect what is displayed. (See section 9-3)

Strength of echoes

The colors indicate differences in the strength of the echo. The strength varies with several factors, such as the:

- Size of the fish, school of fish or other object.
- Depth of the fish or object.

- Location of the fish or object. (The area covered by the ultrasonic pulse is a rough cone shape and the echoes are strongest in the middle.)
- Clarity of water. Particles or air in the water reduce the strength of the echo.
- Composition or density of the object or bottom.

CAUTION

Planing hulls at speed produce air bubbles and turbulent water that bombard the transducer. The resulting ultrasonic noise may be picked up by the transducer and obscure the real echoes.

Bottom types

Mud, weed and sandy bottoms tend to weaken and scatter the sonar pulse, resulting in a weak echo. Hard, rocky or coral bottoms reflect the pulse, resulting in a strong echo.

Frequency and cone width

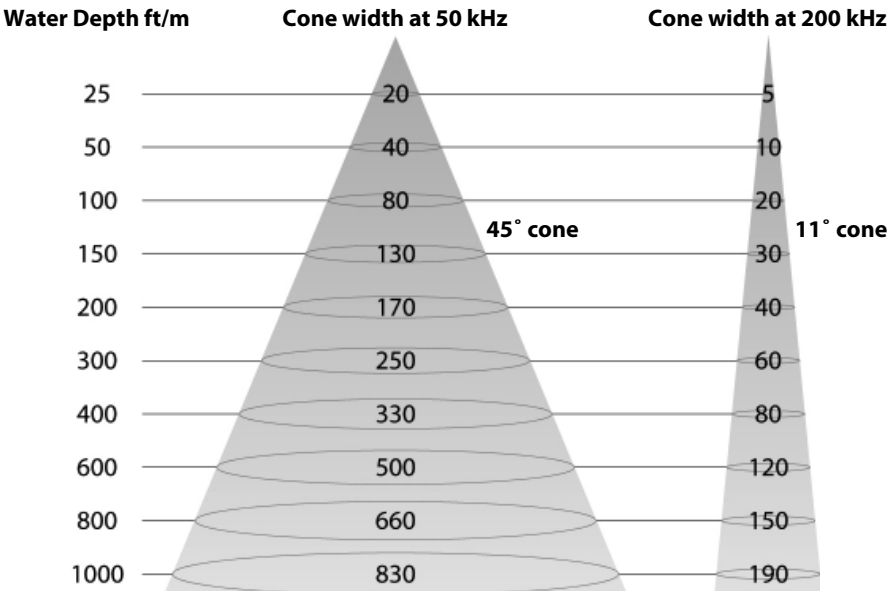

Shadows

Shadows are created around areas where the ultrasonic beam cannot 'see'. These areas include hollows on the bottom or beside rocks and ledges, where the strong echoes returned off the rocks obscure the weak echoes of the fish and may also create a double bottom trace.

Example of shadows

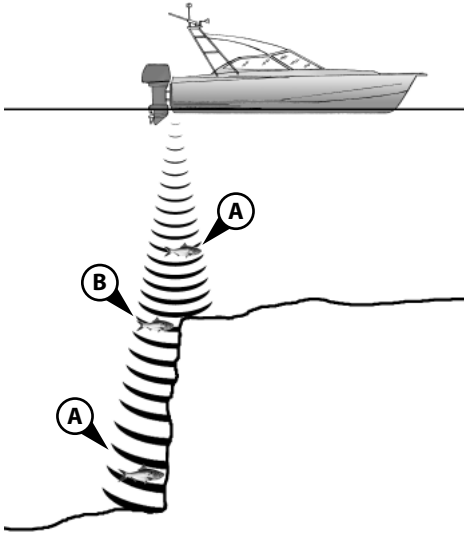

- A** Fish is visible on the window
- B** Fish is hidden by the strong echoes off the bottom and is not shown on the window

9-3 Single and Dual frequency fishfinding

Sonar frequencies

The Instrument has two sonar frequencies, 200 kHz and 50 kHz. To select the sonar frequency to use:

- 1 Go to a sonar window (see section 9).
- 2 Press **MENU**, select **F**requency and select 200 kHz, 50 kHz, or **M**ixed.

See following for an example of the sonar window in such an environment. A double bottom trace is shown on the window.

When looking for fish with the wide angled 50 kHz frequency, be aware of increased shadows. Use the high frequency 200 kHz in areas that have rocks and ledges because this frequency reduces the shadow effect considerably.

Sonar window of same area

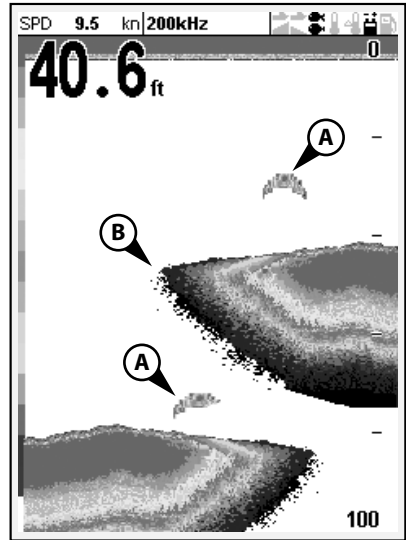

When to use 200 kHz

The 200 kHz frequency is especially suitable for use in shallow and medium depth water, typically less than 500 ft (150 m) and while running at speed.

At 200 kHz, the narrow cone reduces any noise caused by air bubbles.

The 200 kHz frequency generates a higher definition pulse which produces little shadow and returns excellent detail over a small area of bottom. Therefore, it gives excellent bottom discrimination capability and is particularly good at showing individual fish, including bottom dwellers.

When to use 50 kHz

The 50 kHz frequency is particularly suitable for use in deep water, typically greater than 500 ft (150 m).

At 50 kHz, the cone covers an area of water about four times wider than the 200 kHz cone and penetrates to a greater depth with minimal loss of the return signal.

However, it produces a lower definition display with more shadow compared to the 200 kHz frequency. This means that a group of small fish, for example, could be displayed as a single item, while any fish very close to the bottom may not be found at all.

This frequency is useful for getting a deep, wide overview of the area so that any areas of interest can be identified and then examined in detail with the 200 kHz frequency.

When to use Mixed

The Mixed frequency combines the 200 kHz and the 50 kHz echoes on one sonar window, filling in detailed echoes in the centre of the sonar cone.

When to use 50/200 kHz

Operating the Instrument at both 50 kHz and 200 kHz simultaneously on a split window can be very useful when operating in shallow to medium water, typically less than 500 ft (150 m), because the 50 kHz section of the window shows the general area, while the 200 kHz section can be viewed simultaneously for a more detailed look at any interesting feature.

To use 50/200 kHz, select the Split 50/200 window (see section 9-4).

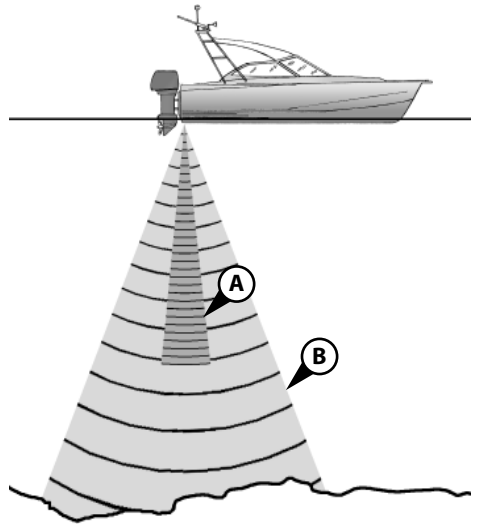

- A** Narrow angle, more detailed 200 kHz cone
- B** Wide angle, less detailed 50 kHz cone

Comparison of the same fish scenario displayed at different frequencies:

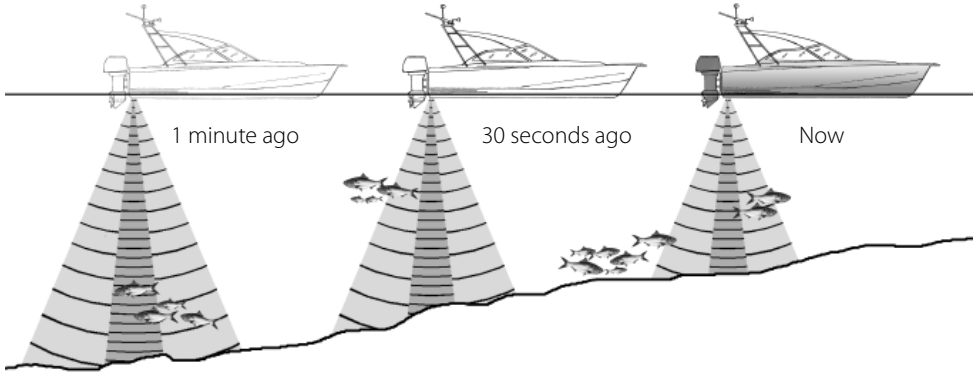

50 kHz display

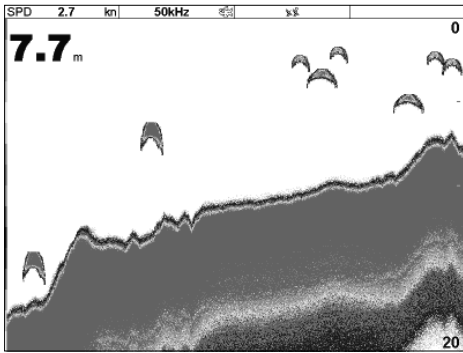

200 kHz display

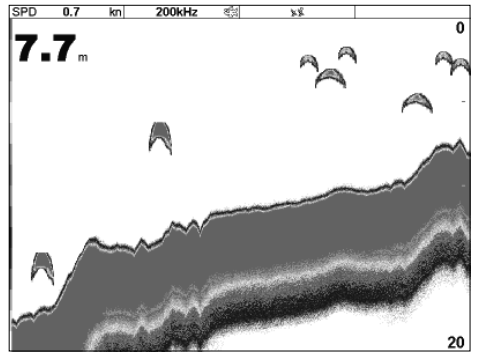

200/50 kHz display

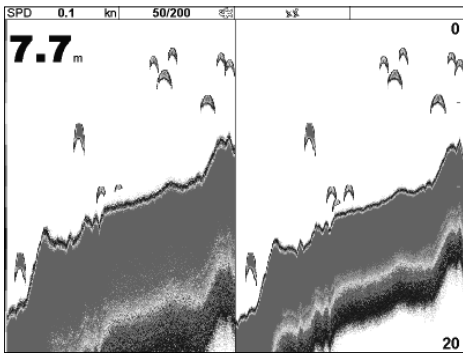

Mixed display

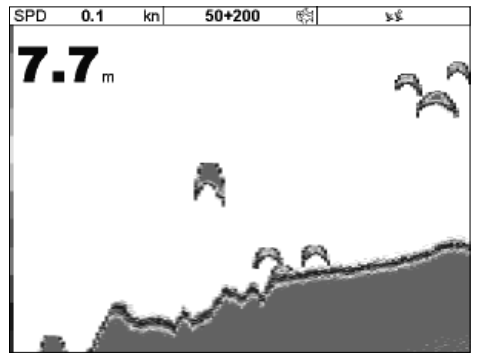

9-4 Fish detection and display

Where to find fish

Underwater features like reefs, wrecks and rocky outcrops attract fish. Use the 50 kHz or 50/200 kHz frequency window to find these features, then look for fish by passing over the feature slowly several times using the Zoom window (see section 9-2). If there is a current, the fish will often be found downstream of the feature.

When fishing with the Instrument with the Fish symbols OFF, a weak fuzzy band may appear between the bottom trace and surface. This might indicate a thermocline - a rapid change in water temperature, such as the edge of a warm or cold current. The temperature difference can form a barrier which the fish may not swim through. In fresh water, fish often collect around a thermocline.

Fish symbols

The Instrument uses Northstar's SBN II technology to analyze sonar echoes and identify which are likely to be fish. The Instrument can be set up to display a fish symbol and the depth over these echoes (see section 19-3, Fish symbols). While SBN II is very sophisticated it is not foolproof - there will be times when the Instrument will not be able to differentiate between fish and large air bubbles or rubbish.

Depending on the strength of a fish signal, the Instrument can display a small, medium or large symbol (see section 19-3, Fish filter).

To see the maximum amount of information from the echoes, turn Fish symbols off. Fish appear as arches on the window.

Fish arches

In good conditions, a fish passing through the cone-shaped ultrasonic pulse is displayed as a fish arch. The 50 kHz frequency uses a wider cone than the 200 kHz frequency. This makes the fish arches easier to see.

A fish arch starts when a fish enters the weak edge of the sonar cone, generating a weak echo that is displayed as the start of the fish arch. As the fish moves closer to the middle of the cone, the distance between the transducer and the fish reduces and the echo is displayed at progressively shallower depths, producing a rising shape. When the fish passes directly beneath the middle of the cone, the echo becomes strongest and thickest. As the fish passes out of the middle of the cone the reverse happens with a progressively weaker and deeper echo.

There are many reasons why fish arches may not be seen. For example:

- Poor transducer installation (see Transom Transducers Installation Guide).
- If the boat is anchored then fish will tend to show on the window as horizontal lines as they swim into and out of the transducer sonar beam. Slow speeds in deeper water give the best fish arch returns.
- Range is important. It will be much easier to see fish arches when using zoom mode to concentrate on a particular section of water, rather than just displaying everything from the surface to the bottom. Zooming increases screen resolution and is necessary for good fish arches.
- It is difficult to get fish arches in shallow water as the transducer sonar beam is very narrow near the surface and fish do not stay within the beam long enough to display an arch. Several fish in shallow water tend to display as randomly stacked areas of color.
- Wave motion may result in distorted fish arches.

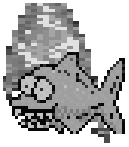

Fun fish symbol

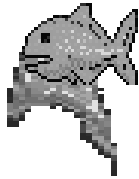

Normal fish symbol



Fun symbol + depth

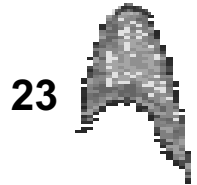

Fish arch + depth

9-5 Range

Range is the vertical depth displayed on the Instrument sonar window. For example, if the range is 100 m, then the sonar window shows depths between 0 and 100 m. The range is displayed at the bottom, right corner of a sonar window.

The Instrument has two range modes:

Auto: The Instrument adjusts the range automatically so that the bottom of the water is always shown at the bottom of the window. Auto range is recommended for normal operation.

To set Auto mode:



- 1 Go to a sonar window (see section 9).
- 2 Press , select Range then Auto.

WARNING

Use the Auto range when learning to use the Instrument or when travelling at speed.

Manual: The Instrument does not adjust the range automatically. If the bottom depth is below the range, the bottom will not appear on the window. Manual range is useful if the bottom depth changes rapidly, because Auto range will cause the window to change range frequently.

To set Manual range or to change the range:

- 1 Go to a sonar window (see section 9).
- 2 Either press  to increase range or press  to decrease range

Zoom range and offset

The sonar Zoom and Bottom windows can show a magnified part of the range (see sections 9-2 and 9-3).

9-6 Gain and threshold

Gain and threshold settings control the amount of detail displayed on a sonar window:

Gain: The gain of the sonar receiver. The gain should be high to display good detail, but if the gain is too high then information from the strong bottom signal is lost and false echoes might be displayed. There is a separate gain setting for each sonar frequency, 50 kHz and 200 kHz.

Threshold: Return echoes less than the threshold are ignored. The threshold should be as low as possible, but if the threshold is too low, unwanted noise will be displayed. Threshold is set as a percentage of gain. For example, if the threshold is 50 %, then return echoes less than 50 % of the maximum signal are ignored. There is a separate threshold setting for each sonar frequency, 50 kHz and 200 kHz.

The gain window

To display or change the current settings for gain, select a sonar window and press **ENTER**. Select **Threshold** to display the thresholds.

Changing mode

Gain	
Mode	Manual
200kHz	20
50kHz	18
Threshold	<input checked="" type="checkbox"/>
200kHz	15%
50kHz	30%

This window is called the gain window.

The Instrument has three operating modes. In Cruising and Fishing modes, the Instrument automatically adjusts gain and threshold for good performance. In manual mode, you can hand adjust the settings.

To change the mode from the Gain window, Select Mode and then select **Fishing**, **Cruising** or **Manual**. When you select **Manual**, the Instrument reverts to your last manual settings.

Changing gain and threshold

- 1 In the Gain window, press **▲** or **▼** to select the setting to adjust.
- 2 Press **◀** or **▶** adjust the setting. The Instrument changes to Manual mode.

Tip: Use the A-scope window to help set gain or threshold manually (see section 10-5).

10 Sonar fishfinding: Windows

To show the Sonar window, press **DISPLAY**, then select **Sonar**.

There are five kinds of sonar window. To use a window, press **MENU**, select **Sonar splits**, then select the type of window to use:

No split: Sonar history window at a single or mixed frequency (see section 10-1).

Split zoom: Sonar history plus a zoomed section (see section 10-2)

Full screen zoom: (see section 10-2)

Split bottom: Sonar history plus a bottom trace in a zoomed section (see section 10-3)

Split 50/200: Sonar histories at 50 and 200 kHz (see section 10-4)

Split A-Scope: Sonar history plus echo strength (see section 10-5)

If the window is split, adjust the split ratio if required:

- 1 Press **MENU** and select **Sonar window split**.
- 2 Press **◀** or **▶** to adjust the ratio.
- 3 Press **ENTER**.

Options	
Sonar splits	No Split
Frequency	No Split
Gain	Split Zoom
Range	Full screen zoom
A-Scope	Split Bottom
MENU for setup	Split 50 / 200
	Split A-Scope

10-1 Sonar history window - no split

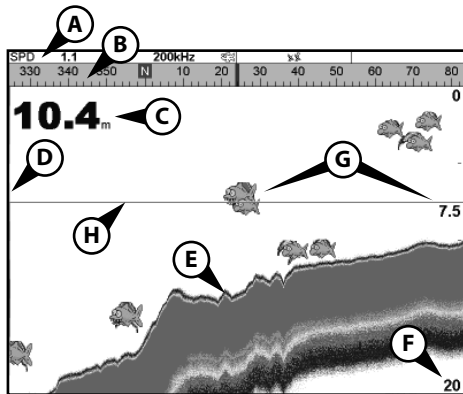

- A** Optional data header (see section 2-7-3)
- B** Optional compass (see section 2-7-4)
- C** Depth
- D** Color bar
- E** Bottom
- F** Range
- G** Fish symbols with depth
- H** Depth line

The window scrolls from right (most recent echoes) to left (oldest echoes).

10-1-1 Extended history mode

To review an old sonar echo, use ◀ and ▶ to move back and forward through the sonar history. The time since the echoes shown on the screen were recorded is displayed at the bottom of the screen. Press **ESC** to return to the most recent echo.

The digital depth shown is always the current depth, even in extended history mode.

The History Position Bar indicates the age of the most recent echo on the screen, and the position of the current screen in the recorded history.

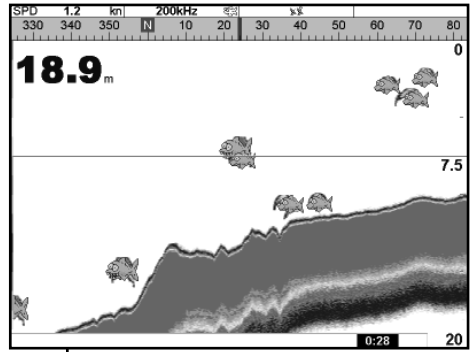

History position bar

10-2 Sonar Zoom and Full Screen Zoom displays

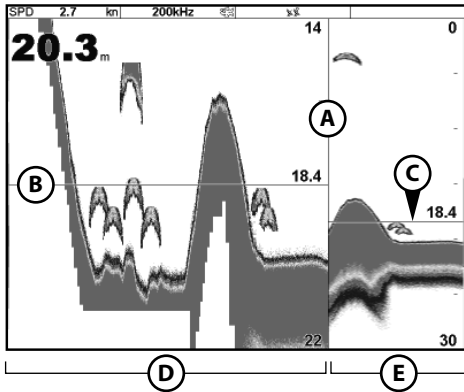

- A** Divider line
- B** Depth line marks the centre of the zoomed area
- C** Zoom bar
- D** Zoom section
- E** Sonar history

These windows show a zoomed section of the sonar history. The Sonar Zoom display shows the sonar history on the right and the zoomed section on the left. The Full Screen Zoom display shows the zoomed section only.

The zoom bar on the far right shows the area of the history that is magnified in the zoom section:

- Press ◀ or ▶ to adjust the zoom range (the range of depths included in the zoom section).
- If **Bottom lock** is on, the zoom depth (the depth of the zoom section) is adjusted automatically so that the bottom is always displayed in the zoom section.

If **Bottom lock** is off, press ▲ or ▼ to manually adjust the zoom depth. If **bottom lock** is on it will turn off.

Bottom lock

To turn **Bottom lock** on or off:

- 1 Press **MENU** and select **Bottom lock**.
- 2 Select **On** or **Off**. Or if **Bottom lock** is on, pressing ▲ or ▼ will turn it off.

10-3 Sonar Bottom window

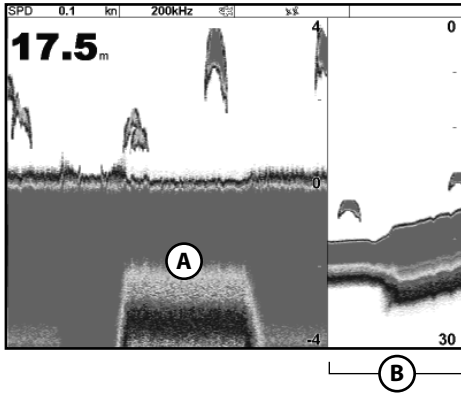

- A** Zoomed bottom signal
- B** Sonar history

The window shows the sonar history on the right and the bottom signal as a flat trace in the centre of the zoom section on the left. The flat trace makes it easy to compare the echo strengths shown in the bottom signals. This can help to identify the type of bottom and objects close to the bottom.

The zoom bar on the far right shows the area of the history that is magnified in the zoom section:

- Use the ◀ or ▶ keys to adjust the zoom range.
- The Instrument calculates the zoom depth automatically.

It is not necessary to turn Bottom lock on for this window.

10-4 Sonar 50/200 window

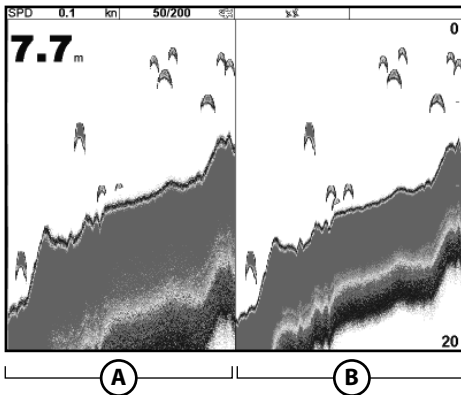

The window shows:

- A** the 50 kHz sonar history on the left
- B** the 200 kHz sonar history on the right.

Gain can be set independently for each frequency (see section 9-6). Range applies to both frequencies (see section 9-5).

10-5 Sonar A-Scope window

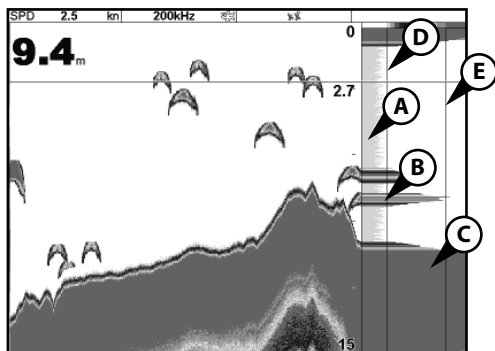

The window shows the sonar history on the left and the A-Scope window on the right. The A-Scope shows:

A, B, C, The strengths of echoes being received now from different depths - the longer the horizontal line the stronger the signal:

- A** Unwanted noise echoes.
- B** Echoes from fish and the bottom
- C** The strongest echo, usually from the bottom
- D** A vertical line showing the threshold, the weakest echo to display on the sonar history
- E** A vertical line showing the gain setting; echoes above this strength will display as the maximum signal strength

Use the A-Scope while adjusting the gain and threshold settings manually (see section 9-6).

Setting gain and threshold

It is convenient to use the A-scope window when adjusting gain and threshold manually. Follow this procedure to adjust gain and threshold for normal circumstances:

- 1 Switch to a sonar window (see section 9). If necessary, press **+** or **-** to adjust range so that the bottom is displayed.
- 2 If necessary, select the sonar frequency to adjust the settings for. Press **MENU**, select **F**requency and select 200 kHz or 50 kHz.
- 3 Press **MENU**, select **S**onar splits then select **S**plit A-scope.

- 4 Press **ENTER** to display the Gain window. To adjust gain or threshold for a frequency, press **▲** or **▼** to select the setting to adjust, then press **◀** or **▶** to change the setting.
- 5 Set threshold to zero.
- 6 Adjust Gain so the peak of the strong signal from the bottom just touches the gain line.
- 7 Adjust threshold so that it is just to the right of the noise.
- 8 Press **ESC** to close the gain window.
- 9 If required, repeat these steps to adjust gain and threshold for the other frequency.

Note: Setting the gain higher will display more detail from weak echoes, like fish, but will lose detail from the strong echo from the bottom.

Fish recognition

The echo strengths shown on the A-scope can be useful in recognizing the type of fish. Different species of fish have different sizes and shapes of swim bladders. The air in the swim bladder reflects the ultrasonic pulse, so the strength of the echo varies between fish species according to the size and shape of the swim bladder.

When catching fish from a school, note the species and the strength of the echo that it returns on the A-scope. Then, when that particular echo is seen again, it is likely to be the same fish species.

Bottom type

The shape of the echo strengths in the A-Scope can help you to recognise the type of bottom.

11 Gauges window

The Gauges window shows boat data, such as water speed, as analog gauges. To select the Gauges window, press **DISPLAY**, select More, then select Gauges. Before using the Gauges window, set Speed range, Max RPM and Max fuel flow (see section 19-13).

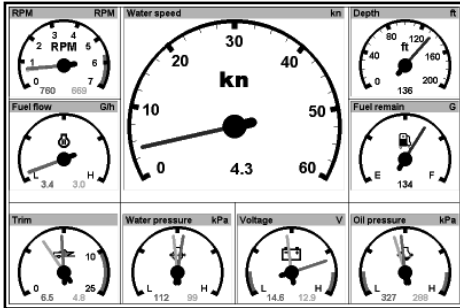

Selecting a Gauges layout

The Gauges window can show one of four gauge layouts. To select a layout from the Gauges window, press **MENU**, select Layout and select a layout.

Changing a gauge layout

You can change the data displayed on each gauge in a layout.

- 1 Select the layout to change (see above).
- 2 Press **MENU** and select Gauge setup.
- 3 Highlight the gauge to change. Press **ENTER** and select the data to display in the gauge.
- 4 Repeat the above step to change other gauges.
- 5 Press **ESC**.

12 Data window

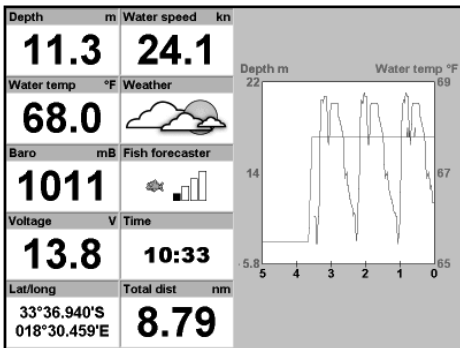

The data window has large numeric data fields and a graph of depth and water temperature if available. To go to the data window, press **DISPLAY**, select More, then select Data.

To select what data is displayed:

- 1 Press **MENU** and select Data setup.
- 2 Change a data field:
 - i Press the cursor keys to highlight the field.
 - ii Press **ENTER** to display a menu of data items.
 - iii Select a data item that is available on your system or select None to leave the field empty.
- 3 Repeat the above step to set the other data fields.
- 4 Press **ESC**.

13 Fuel functions and display

The Fuel functions require optional petrol/gasoline or SmartCraft fuel sensors to be installed and set up.

13-1 What the fuel computer does

Each engine has a flow sensor installed to measure the engine's fuel flow.

The M121/M84 use these flows, together with boat speed and engine RPM if available to estimate the fuel remaining in the tank(s), fuel used, range and fuel economy. This data is displayed on the fuel display (see section 13-2).

You can:

- display the fuel used during a trip (see section 13-2)
- set low fuel alarms (see section 13-4)
- make fuel consumption curves - graphs of fuel consumption and boat speed as a function of engine RPM - to monitor and optimize boat performance. (see section 13-6)

⚠ WARNING

To ensure the fuel data is accurate:

- When you add or remove fuel from a tank, tell the M121/M84 (see section 13-3)
- If the boat has petrol/gasoline sensors, calibrate them during installation or if the fuel readings seem inaccurate (see section 13-7)
- Choose an appropriate type of boat speed sensor to calculate economy, range and the fuel consumption curve (see section 13-5)
- If the boat uses a paddlewheel sensor to measure speed, calibrate it during installation or if the speed readings seem inaccurate.

13-2 Fuel display

Fuel display

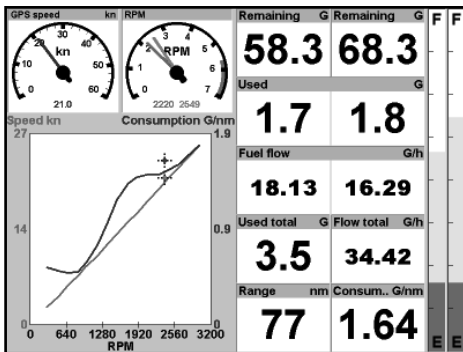

To go to the Fuel display, press **DISPLAY**, select **More**, then select **Fuel**.

The display differs according to the number of engines and tanks. If engine RPM is available and if you have made and selected a Fuel Consumption Curve (see section 13-6), press **↻** to switch between a Summary or a Fuel curve display.

The Fuel display shows

Speed

To select a boat speed sensor, see section 13-5-1.

RPM (if available)

If engine RPM is not available, the display shows depth.

Remaining

The fuel remaining in the tank(s) is shown as a vertical gauge on the right of the display. The height of the yellow bar(s) show how much fuel remains in the tank(s). If you have set a low fuel alarm (see section 13-4), a red bar shows the level at which the alarm will trigger. If there are two tanks, the left bar shows the port tank, the right bar shows the starboard tank.

Used

The fuel used during a trip. On a multi-engine boat, the data for the port engine is on the left of the display.

When you want to start measuring how much fuel is used, go to the Fuel display and:

- In a single engine boat, press **MENU** and select **Clear used**.
- In a multi-engine boat, the fuel used by each engine and the total fuel used are shown. Press **MENU**, select **Clear used** and select:
 - **Port** or **Starboard** to clear the fuel used by one engine
 - **Both** to clear the total fuel used.

13-3 When you add or remove fuel

When you add or remove fuel, you must tell the M121/M84, otherwise the fuel data will be meaningless.

A When you completely fill a tank

Go to the fuel display and press **MENU**.

Then:

- On a single-tank boat, select **Fill tank**.
- On a multi-tank boat, select **Fill tank**, then select the tank you have filled.

Note: Underfloor fuel tanks are often difficult to refill to the same level twice, due to air pockets.

With underfloor fuel tanks:

- Trim the boat to the same angle in the water each time you follow procedure A.
- Mostly use procedure B below when adding fuel, but completely fill the tank and follow procedure A about every tenth time you add fuel.

Fuel flow

The fuel flow for the engine(s). On a multi engine boat, the data for the port engine is on the left of the display. Use the flows to check the load of each engine.

Range

The estimated boat range at the current fuel flow. The value can depend on the type of speed sensor (see section 13-5).

Economy

The distance travelled per unit of fuel used. The value can depend on the type of speed sensor (see section 13-5). The larger the value, the better the fuel economy. Adjust the throttle and trim to achieve the best economy.

Fuel consumption curve

A graph of fuel consumption and boat speed as a function of engine RPM. Use the curve to monitor and optimize boat performance (see section 13-6).

B When you part fill a tank

- 1 Add fuel to a tank and write down how much fuel you add.
- 2 From the Fuel display, press **MENU** and select **Add fuel**.
- 3 On a multi-tank boat, select the tank that you have added fuel to.
- 4 Change the number to the amount of fuel that you added.

Note: If you follow procedure B every time you add fuel, then a small error will accumulate, because it is hard to measure exactly how much fuel you add. To avoid this, completely fill the tank and follow procedure A about every tenth time you add fuel.

C When you remove fuel

1. Before removing fuel, go to the Fuel display, press **MENU** and select **Set remaining**.

2. On a multi-tank boat, select the tank that you are removing fuel from.
3. Write down the value of Remaining for the tank; this is the amount of fuel originally in the tank.
4. Remove fuel from the tank and write down how much fuel you remove.
5. Subtract the amount of fuel you removed from the amount of fuel originally in the tank to calculate the amount of fuel now in the tank.

6. Change the number on the Set Remaining menu to the amount of fuel that you calculated was now in the tank.
7. Press **ENTER**

Note: You can also use this procedure when you add fuel to a tank. In this case, add the fuel you have added to the amount of fuel originally in the tank to calculate the amount of fuel now in the tank.

13-4 Low fuel alarm

To set a low fuel alarm for a tank:

- 1 Press **MENU** twice, select **Fuel**, then select **Setup tanks**.
- 2 On a multi-tank boat, select the tank to set the alarm for.
- 3 Select **Tank alarm** and enter a fuel level to trigger the low fuel alarm; or enter zero to disable the alarm.

When a low fuel alarm is set, the alarm's fuel level is shown on the fuel display tank levels as a red bar. The alarm can also be set using the Alarms setup menu (see section 19-10)

13-5 Boat speed sensors

13-5-1 Selecting a boat speed sensor

The fuel calculations can use boat speeds from the GPS, or from a paddlewheel sensor or pitot sensor if these optional sensors are installed:

- Paddlewheel and pitot sensors measure the speed through the water; GPS speed is speed over ground; these sensors can give different values for Range, Economy and the fuel consumption curves (see section 13-5-2).
- A pitot sensor is more accurate than a paddlewheel sensor at high speeds but is not accurate at low speeds. A paddlewheel sensor is more accurate than a pitot sensor at low speeds.

To select an optional speed sensor

- 1 Press **MENU** twice, select **Fuel**, then select **Speed source**.
- 2 To use a paddlewheel or pitot sensor, select **Water speed**, otherwise select **Ground speed** to use GPS speed.
- 3 If you selected **Water speed** and you have both a paddlewheel sensor and a pitot sensor:
 - i Press **ESC**, select **SmartCraft** and select **Speed type**
 - ii Select **Paddlewheel** or **Pitot**.

Tip: You can select a different speed sensor during a trip.

13-5-2 Water speed and ground speed

A paddlewheel sensor and a pitot sensor measure water speed, the boat speed through the water. A GPS measures ground speed, the boat speed over the bottom of the water. If there is a current, then these speeds will be different, and the log, trip log, economy and range will be different, as shown below.

Water speed is better for measuring the boat's potential performance, Ground speed is better for going to a destination because it takes currents into account. To select a speed sensor, see section 13-5-1.

When the current is from ahead, ground speed is less than water speed

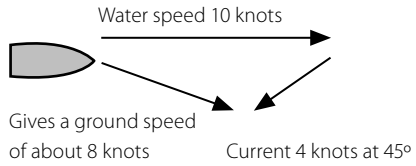
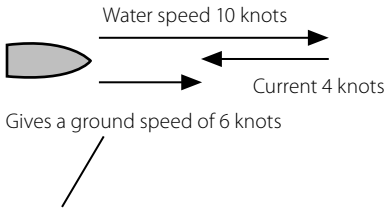

For this example:

If the boat travels for one hour, uses 3 gallons of fuel per hour and has 50 gallons of fuel left:

	Speed	Log	Economy	Range
Using water speed:	10 knots	10 nm	3.3 nm / gal	165 nm
Using ground speed:	6 knots	6 nm	2.0 nm / gal	100 nm

When the current is from behind, ground speed is more than water speed

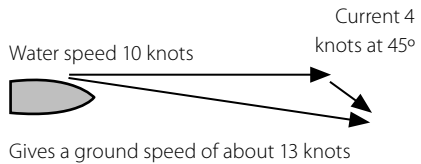
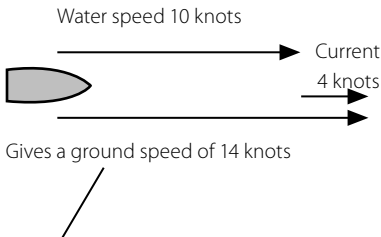

For this example:

If the boat travels for one hour, uses 3 gallons of fuel and has 50 gallons of fuel left:

	Speed	Log	Economy	Range
Using water speed:	10 knots	10 nm	3.3 nm / gal	165 nm
Using ground speed:	14 knots	14 nm	4.7 nm / gal	235 nm

13-6 Fuel consumption curves

A fuel consumption curve shows fuel consumption (fuel used per unit of distance travelled) and boat speed as a function of engine RPM. Fuel consumption curves require engine RPM, which requires SmartCraft to be installed. Fuel consumption curves are powerful tools for assessing boat performance in different conditions and for helping you to run at the most economical speed for the conditions.

13-6-1 Making a fuel consumption curve

To make a fuel consumption curve you will need to run the boat in a straight line for about 15 minutes using the engine's full RPM range. For your first curve, choose a calm day with light wind and little current; have a typical load and a freshly cleaned hull. Later, you can make fuel consumption curves for different boat, weather or sea conditions. Compare these with your first curve to see how your boat's performance changes with conditions.

Making a curve

- 1 Start running the boat in a straight line.
- 2 Choose a speed source for the curve (see section 13-5-1). Normally choose Water speed to measure the boat's potential performance.
- 3 Press **MENU** twice, then select **Fuel**.
- 4 Select **Fuel consumption curve**, then select **New**.
- 5 Enter the comfortable maximum RPM you know you can achieve for the engine rather than the maker's value.

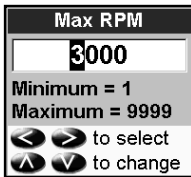

- 6 The M121/M84 then asks you to set the minimum RPM. Set the throttle to idle; on a multi engine boat set all engines to about the same idle RPM.
Now, do not change the engine speed. Wait for about 60 seconds for the boat to stabilise, then press **ENTER**. Wait while the fuel computer records the data.
- 7 The M121/M84 then asks you to set the throttle to achieve a target RPM. On a multi engine boat set all engines to about the target RPM. When the engine RPMs are correct, the Target RPM box will turn green. Now, do not change the engine speed.

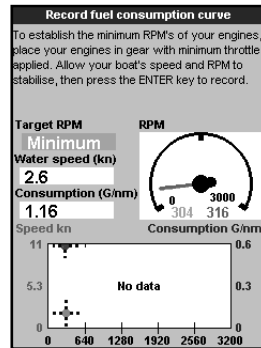

- Wait for about 60 seconds for the boat to stabilise, ensuring the Target RPM box stays green. Then press **ENTER**. Wait while the fuel computer records the data.
- 8 The M121/M84 repeats the above step to record data up to the maximum RPM. Then the M121/M84 asks if you want to save the curve. Select **Yes**. The fuel computer asks for a name for the curve. Change the default name if required. Then press **ENTER**. The M121/M84 stores the new curve.

Note To interrupt making the curve at any time, press **ENTER**.

13-6-2 Managing fuel consumption curves

Renaming a curve

- 1 Press **MENU** twice, then select Fuel.
- 2 Select Fuel consumption curve. Select Name and select the name of the curve to rename.
- 3 Select Rename and press **ENTER**. Change the name.

13-6-3 Using fuel consumption curves

Deleting a curve

- 1 Press **MENU** twice, then select Fuel.
- 2 Select Fuel consumption curve. Select Name and select the name of the curve to delete.
- 3 Select Delete.

Selecting a curve

- 1 You must make a fuel consumption curve before you can use it (see section 13-6-1).
- 2 On the Fuel display, press **MENU**, select Fuel consumption curve and select the name of the curve to use.
- 3 On the fuel display, press **▶** if necessary to select Fuel curve and display the fuel consumption curve.

Note

- a On a multi engine boat, keep the RPM of all engines similar while using a curve.
- b The shape of the curve depends on the type of speed sensor you selected when making the curve (see sections 13-5-1 and 13-5).

Using a curve

Compare your boat's performance now, at the current RPMs, with the boat's performance when you made the curve. You can compare your boat's performance now with a curve made under ideal conditions or with a curve made under similar conditions.

Information in a curve

- A** RPM of the boat now. For a twin engine boat, the RPM is the average of the two RPMs.
- B** Red curve: boat speeds at different RPMs recorded when you made this fuel consumption curve.
- C** Red marker: the boat speed now. This marker is below the red curve, showing that the boat speed now at this RPM is less than when you recorded the curve.
- D** Blue curve: fuel consumption at different RPMs recorded when you made this fuel consumption curve.
- E** Blue marker: the fuel consumption now. This marker is below the blue curve, showing that the fuel consumption now at this RPM is better than when you recorded the curve.
- F** If the blue curve has a dip, then running the boat at this RPM will give the best speed for the least fuel consumption.

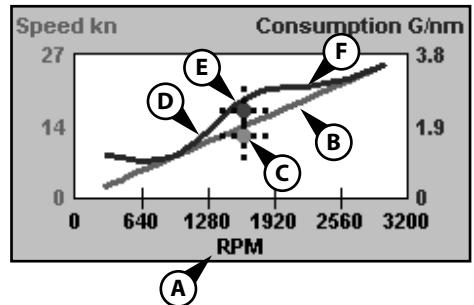

13-7 Calibration

Calibrate petrol/gasoline fuel flow sensors during installation, or if the fuel readings seem inaccurate and the other troubleshooting suggestions do not help (see Appendix B troubleshooting).

Note

- SmartCraft fuel sensors are factory calibrated and should never need recalibrating.
- On a multi engine boat, calibrate each engine's sensor. This can be done at the same time with a portable tank for each engine or at different times using one portable tank.
- Calibrating a sensor requires accurate measurement of the fuel consumption. This is best done using a small portable tank. At least 4 gallons (15 litres) of fuel should be used to ensure an accurate calibration.
- It is often very difficult to fill underfloor tanks to the same level twice due to air pockets, so the more fuel used, the more accurate the calibration.

To calibrate the sensor(s):

- 1 Record the level of the fuel in the tank(s).
- 2 Connect the portable tank(s) to the engine through the fuel sensor(s).
- 3 Run the engine at normal cruising speed until at least 4 gallons (15 litres) of fuel has been used per engine.
- 4 Check the actual amount of fuel used per engine by refilling the portable tank(s) to the original level and noting the reading(s) of the fuel dispenser's gauge.
- 5 Press **MENU** twice, select **Fuel**, then select **Setup engines**.
- 6 On a single engine boat, select **Calibrate** and change the displayed value to be equal to the reading of the fuel dispenser's gauge, then press **ENTER**.
On a multi-engine boat select the engine. Select **Calibrate** and change the displayed value to be equal to the reading of the fuel dispenser's gauge, then press **ENTER**. Repeat for the other engines.

14 Tides window

The tides window is available on Chart cards. The tides window shows tide information at a tide station for the selected date.

CAUTION

The tides window requires the local time offset to be set to work correctly (see section 19-14)

To show the tides window for the tide station nearest to the boat, press **DISPLAY**, select **More**, then select **Tides**.

To go to the tides window for any tide station:

- 1 From the chart window, press **MENU** and select **Find**.
- 2 Select **Tide stations**.
- 3 A list of tide stations are displayed. Select the tide station to display. The chart redraws with the tide station centred.
- 4 Press **MENU** and select **Chart info**.
- 5 Select **Tide height**.

Choosing the date of the tide chart

- 1 From the tides window, press **MENU**.
- 2 Select **Today**, **Next day** or **Prev day**.
To choose a different date from these, select **Set date**, edit the date, press **ENTER**.

The tides window shows data for the chosen date

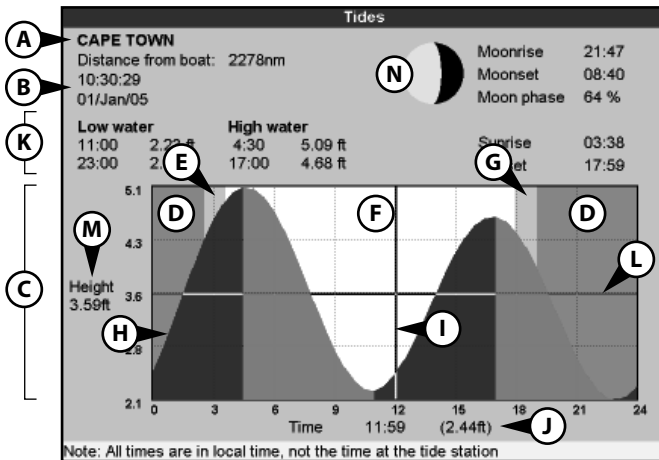

- A** Tide station name and distance from boat
- B** Current time and chosen date for display
- C** Tide chart
- D** Night
- E** Dawn
- F** Day
- G** Dusk
- H** Tide height
- I** Time cursor, a vertical dotted line. Press **←** or **→** to move cursor sideways
- J** Time of cursor and tide height at that time
- K** Data for the chosen date
- L** Tide height cursor, a horizontal dotted line. Press **▲** or **▼** to move cursor up and down.
- M** Height of cursor on the tide chart
- N** Moon phase for moon at the current time on the chosen date

15 User card window

A user card is an optional plug-in card that can store data files (see section 1-3). There are three types of files: waypoints, routes or a track.

To go to the user card window, press **DISPLAY**, select **More**, then select **User card**.

CAUTION

- 1 Before using a user card, remove any chart card and plug the user card in. When you have finished with the user card, remove the user card and replace the chart card (see section 1-3).

The user card window has:

File list

A list of the files on any user card in the Instrument. If there are more files than will fit on the window, press **+** or **-** to scroll up or down a page at a time.

Waypoints, Routes

The number of waypoints and routes currently in the Instrument.

Track 1 to Track 5

The number of points in tracks 1 to 5 currently in the Instrument.

Note:

- 1 To save Instrument data onto the user card, use the **Save** command (see below).
- 2 Data stored on the user card and shown on the file list is not available to be used by the Instrument until loaded into the Instrument with the **LOAD** command (see below).

Saving data to the user card

This saves all the Instrument's waypoints, all the Instrument's routes or one of the Instrument's tracks to one file on the user card.

- 1 Press **MENU** and select **Save**.
- 2 Select **Waypts**, **Routes** or **Tracks**.
- 3 For **Tracks**, select the track number to save.
- 4 The new file is created. Change the name if required. The new file appears in the file list.

Loading data from the user card to the Instrument

This loads one file from the user card to the Instrument:

User card			
Slot 1			
Name	Type	Date	Time
Slot 1: Device not formatted			
Slot 2: Device not formatted			
In memory		Track 2:	0
Waypts:	52	Track 3:	0
Routes:	10	Track 4:	0
Track 1:	405	Track 5:	0

- A waypoints file: The new waypoints are added to any existing waypoints in the Instrument. If a new waypoint has the same name as an existing waypoint but has different data, the Instrument displays both waypoints. Select:
 - Skip:** Do not load the new waypoint.
 - Replace:** Load the new waypoint and replace the existing one.
 - Skip all:** Do not load any new waypoints which have the same names as existing waypoints.
 - Rplc all:** Load all new waypoints which have the same names as existing waypoints; the new waypoints replace the existing waypoints.
- A routes file: The new routes are added to any existing routes in the Instrument. If a new route has the same name as an existing route but has different data then the Instrument asks which route to keep.
- A track file: The new track will replace the existing track in the Instrument.

To load a file to the Instrument:

- 1 Select the file to load.
- 2 Press  and select Load.

Deleting a file from the user card

- 1 Select the file to delete.
- 2 Press  and select Delete.
- 3 Select Yes to confirm.

Rereading the file information

This reads the file names from the user card and displays them. Reading does not load any file data into the Instrument. You should not need to do this.

- 1 Press  and select Card.
- 2 Select Read.

Formatting the user card

Formatting prepares a user card for use. Format the card if there is an error message saying that the card is not formatted. Any data files on the card are deleted.

- 1 Press  and select Card.
- 2 Select Format.
- 3 Select Yes to confirm.



Do not format a chart card.

Sorting the file names

This sorts the displayed file names.

- 1 Press  and select Sort.
- 2 Select sort by Name, Type or Time.

16 AIS

AIS is short for Automatic Identification System. The International Convention for Safety of Life At Sea (SOLAS) requires all vessels greater than 300 tons and all passenger vessels to be equipped with AIS Transponders. All vessels equipped with AIS permanently broadcast via one or more of the two dedicated VHF channels. This transmission may include information about the vessels MMSI-number, its call sign, name, position, course, heading, speed, rate of turn and type of vessel.

This unit can receive and display AIS information when connected to an AIS receiver. Available AIS vessels transmitting in the local

area are shown on the chart when this feature is enabled.

The following AIS receivers are supported by this unit:

- Comar SLR200 (external GPS).
- Weatherdock Two Channel AIS Receiver "EASY AIS", Part No. 5-A-013 (external GPS).
- NASA Marine AIS Engine 2 channel Receiver (external GPS).

Other AIS receivers may work but have not been tested with this unit.

To enable AIS from the system menu check the AIS box. (see section 16-3)

16-1 Viewing AIS Vessels

A typical AIS window shows:

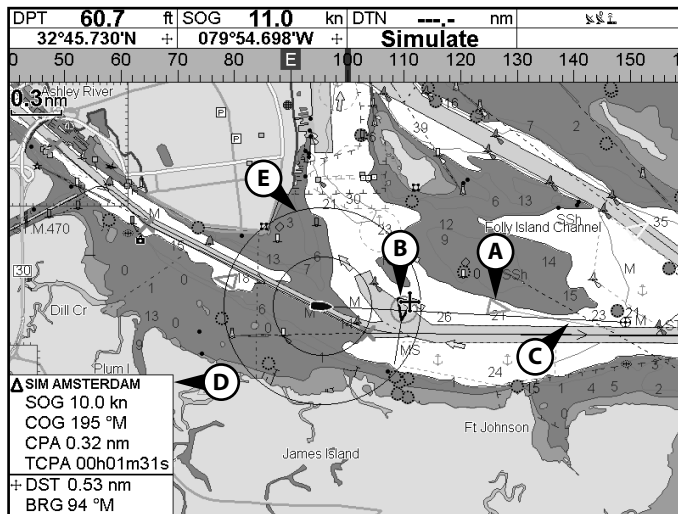

- A** AIS Vessel
- B** Dangerous Vessel
- C** Projected Course
- D** Data Box
- E** Range Rings

When the cursor is placed over an AIS vessel for at least two seconds, a data box appears at the bottom of the window with information about the AIS vessel.

For complete AIS information on the AIS vessel place the cursor over an AIS vessel for at least two seconds and press **ENT**.

Press either **ENT** or **ESC** to clear the information.

Vessel info: SIM SOUTHAMPTON

Position 36°28.133'S	COG 302°M
175°07.628'E	SOG 20.0 kn
Heading 302°M	BRG 18°M
ROT 2°/min	DST 51.8 km
MMSI 546561894	CPA Invalid
Callsign SOU	TCPA Invalid
IMO 0	

Nav status Under way

Type HSC - IMO Hazard C	 <p style="font-size: small; text-align: center;">Antenna Location</p>
Dest SOUTHAMPTON, UK	
ETA Aug 08, 08:48	

Length 98.4 ft	
Beam 16.4 ft	
Draught 6.6 ft	

to continue

16-2 Dangerous Vessels

The M121/M84 calculates the time of closest approach (TCPA) and closest point of approach (CPA) for each AIS vessel.

This is used to determine potential dangerous vessels. If the TCPA and the CPA is below the trigger values then it will be considered dangerous. (See section 19-8 for setting the dangerous vessel alarm)

A dangerous vessel is indicated on the chart by a red circle around the icon.

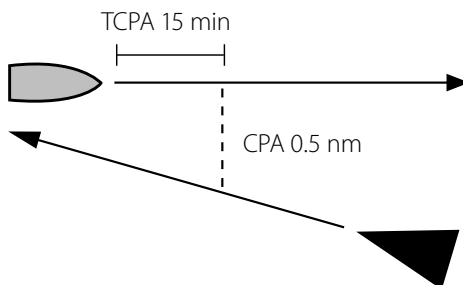

16-3 AIS Windows

To go to the AIS windows, press **DISP**, select **More**, select **AIS**, then press **←** or **→** to select one of the two windows: **Vessels** or **Safety msgs (rx)**.

If there are more items than will fit on the window, press **+** or **-** to see the others.

AIS						
Vessels			Safety msgs (rx)			
DST (km)	SOG (kn)	BRG (°M)	MMSI	Name	CPA (km)	TCPA hh:mm:ss
1.96	9.0	134	987654321	SIM AUCKLAND	0.48	00h04m00s
3.84	10.0	121	721198100	SIM AMSTERDAM	0.58	00h06m31s
7.50	9.9	108	894351656	SIM GENOVA	2.14	00h16m47s
11.2	21.5	120	498121654	SIM LA ROCHELLE	2.33	00h10m55s
6.23	2.1	102	156649841	SIM CAPETOWN	3.65	00h18m21s
25.1	0.0	123	496819156	SIM OSLO	5.91	01h11m54s
29.4	20.0	113	546561894	SIM SOUTHAMPTON	27.6	00h12m41s
31.6	15.9	124	891316884	SIM SAN FRANCISCO	27.8	00h23m22s
43.5	15.1	69	156164988	SIM SYDNEY	36.9	00h28m49s
4.97	21.4	115	123456789	SIM CHARLESTON	Invalid	Invalid

to page up/down

Vessels

This is a sorted list of vessels currently being received by the AIS receiver. The maximum number of vessels that the system will support is 250. Once maximum is reached, vessels furthest away from the current location will be replaced. A vessel will be removed from the list if no information is received within 6 minutes from the last message.

Displaying an AIS vessel on the chart

- 1 Press **▲** or **▼** to select a vessel.
- 2 Press **MENU** and select **Display**. The Instrument switches to chart window, with the selected vessel position in the middle.

Displaying Full AIS Details

- 1 Press **▲** or **▼** to select a vessel.
- 2 Press **MENU** and select **More Info** or press **ENT**.

This window displays all information for the selected AIS vessel provided by the AIS receiver.

Sorting Vessels

Press **MENU**, select **Sort** and select one of the options.

This sorts the list based on the chosen category.

Safety msgs (rx)

Safety msgs (rx) are broadcasted messages received by the AIS receiver. This window displays the date and time of message received, MMSI of AIS vessel that broadcasted the message, and the message itself. Safety msgs (rx) list will store up to 10 messages. The oldest message is replaced when the list is full.

Vessels		AIS
Time	MMSI	Message
09:35:01 02/May/87	546946501	Iceberg, right ahead!
10:42:34 08/Nov/88	584988954	Man overboard! Man overboard!

← to page up/down

17 DSC/Buddy track windows

Buddy track requires an optional Northstar DSC VHF radio to be installed. Buddy track tracks other boats which have DSC radios connected to their GPS receivers by NavBus and are in VHF range. For information on setting up and using the VHF radio for buddy track, see the radio's operation manual.

To go to the DSC windows, press **DISPLAY**, select **More**, then press **◀** or **▶** to select one of the three windows: Distress, Poll or Buddy track. If there are more items than will fit on the window, press **+** or **-** to see the others.

17-1 The windows

DSC Buddy track				
Distress	Poll	Buddy track		
Date	Latitude	Longitude	Name	MMSID
01/Jan/05 10:30:05	00°00.666'N	000°00.666'E	Bob	124122316
01/Jan/05 10:34:55	00°00.666'N	000°00.666'E	Bob	124122316
01/Jan/05 10:33:55	00°00.666'N	000°00.666'E	Bob	124122316

Disabled send addr: **▶** **▶** to page up/down

DSC Buddy track				
Distress	Poll	Buddy track		
Date	Latitude	Longitude	Name	MMSID
01/Jan/05 10:32:27	00°00.000'N	000°00.000'E	John	126643621
01/Jan/05 10:30:48	00°00.000'N	000°00.000'E	Reuben	105285716
01/Jan/05 10:30:37	00°00.000'N	000°00.000'E	Paul	447427149
01/Jan/05 10:30:27	00°00.000'N	000°00.000'E	Peter	513318886
01/Jan/05 10:30:17	00°00.000'N	000°00.000'E	Shane	143053013
01/Jan/05 10:30:08	00°00.000'N	000°00.000'E	Mark	422782911
01/Jan/05 10:34:57	00°00.000'N	000°00.000'E	John	126643621
01/Jan/05 10:34:47	00°00.000'N	000°00.000'E	Reuben	105285716
01/Jan/05 10:34:37	00°00.000'N	000°00.000'E	Paul	447427149

▶ **▶** to page up/down

DSC Buddy track	
Distress	Buddy track
Mark MMSID: 422782911 Position: 00°04.761'N 018°29.722'E Time: 10:31:27	
Shane MMSID: 143053013 Position: 00°01.860'N 000°01.860'W Time: 10:31:27	
Peter MMSID: 513318886 Position: 00°03.860'N 000°03.860'E Time: 10:31:27	
Paul MMSID: 447427149 Position: 00°05.840'E 000°05.840'W Time: 10:31:27	
Reuben MMSID: 105285716 Position: 00°04.660'E 000°04.660'E Time: 10:31:27	
John MMSID: 126643621 Position: 00°02.700'E 000°02.700'W Time: 10:31:27	

Distress

Boats that have sent DSC distress messages and their positions.

Poll

Boats you have manually polled on the VHF radio, and their position at that time.

Buddy track

Buddy boats from your DSC radio. The radio regularly calls the boats and updates their positions.

When your DSC radio receives a distress message, the Instrument creates a distress waypoint at the boat position. Distress waypoints have default names like DSTRSS01. The Instrument displays a Distress warning. Select:

- **OK** to return to what you were doing.
- **Display** to switch to Chart and display the position of the boat sending the distress message.

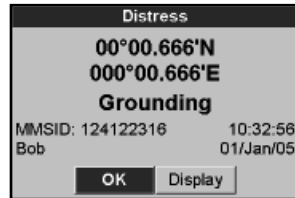

Boat positions

The boat positions on the Instrument can differ from the true boat positions:

Distress: The position is the distress waypoint, which is where the boat was when it sent the distress message.

Polled boats: The position is where the boat was when you last polled the boat.

Buddy track: The position is where the boat was when your radio last polled the boat.

17-2 Using the windows

Displaying a boat on the chart

- 1 Press **▲** or **▼** to select a boat.
- 2 Press **MENU** and select **Display**. The Instrument switches to chart window, with the selected boat position in the middle (see Boat positions above).

Going to a boat

- 1 Press **▲** or **▼** to select a boat.
- 2 Press **MENU** and select **Goto**. The Instrument starts navigating to the boat's position (see Boat positions 17-1).

Creating a waypoint

Polled and buddy track boats are not waypoints. To create a waypoint at the position of a polled boat (see Boat positions above):

- 1 Press **▲** or **▼** to select a boat.
- 2 Press **MENU** and select **Create waypoint**. Edit the waypoint data if required (see section 6-2-7).

Editing a waypoint

A distress message creates a waypoint for the boat or you can create a waypoint at a polled boat's position. To change the data of these waypoints:

- 1 Press **▲** or **▼** to select a boat.
- 2 Press **MENU** and select **Edit waypoint**. Edit the waypoint data if required (see section 6-2-7).

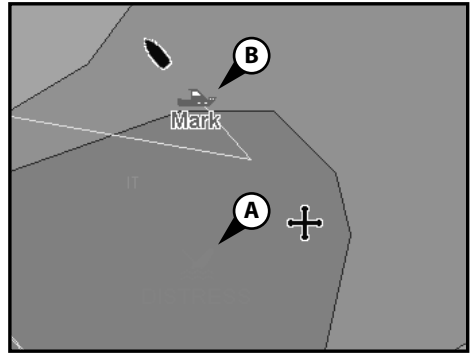

On a chart window:

- A** Distress boats are distress waypoints
- B** Buddy track boats are buddy symbols

Deleting a boat

At the Distress or Poll windows:

- 1 Press **▲** or **▼** to select a boat.
- 2 Press **MENU** and select **Delete**. The boat is deleted from that window. Delete any boat waypoint manually (see section 6-2-5).

Buddy track boats automatically disappear from the Buddy track window when your DSC radio can not pick up their signal.

Deleting all boats

At the Distress or Poll windows:

- 1 Press **▲** or **▼** to select a boat.
- 2 Press **MENU** and select **Delete all**. All boats are deleted from that window and any boat waypoints are deleted.

18 Radar

Radar is the Radio Detection And Ranging system. Radar functions require an optional Northstar radar system to be installed. Three radar systems are available; 2 kW, 4 kW, or 6 kW.

When the radar is operating, the scanner transmits powerful microwave radio pulses which are reflected back from any solid objects such as land masses or other boats. These objects are called targets and are shown on the radar window.

The scanner rotates through 360° so the radar window shows all of the area around your boat within the range of the scanner, producing a map-like display called the PPI (Plan Position Indicator).

Typically, your boat is in the centre of the radar window with concentric range rings surrounding it. The range rings help you to quickly estimate the distance to various targets. If you prefer to view the radar overlaid on the chart screen see section 3-2-7.

18-1 Radar window

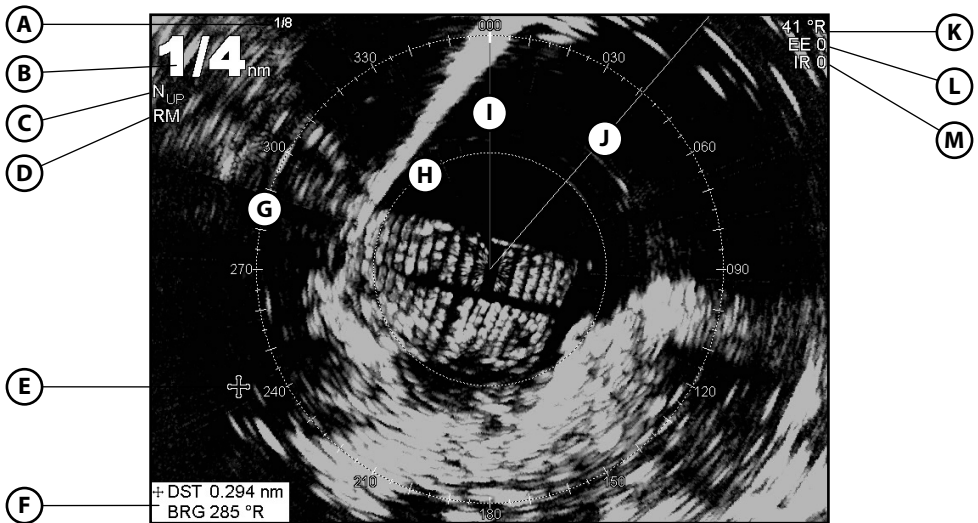

The radar window shows:

- A** Distance between each range ring (in this example, 1/8 nautical mile)
- B** Range of radar (in this example, shown in large digits)
- C** Radar rotation (in this example, North Up)
- D** Radar motion mode (in this example, Relative Mode)
- E** Cursor
- F** Distance and bearing to the cursor position

- G** Compass ring
- H** Range ring
- I** North line (blue)
- J** Heading line (white)
- K** The bearing (in Relative, True, or Magnetic mode)
- L** Echo Expansion setting
- M** Interference Rejection setting

18-2 Radar modes

There are four radar modes:

- Disabled. This saves on power consumption and magnetron usage. If the radar is disabled, it has to warm up and enter standby mode before it can start transmitting.
- Warming. The radar on and is warming up. This can take up to 90 seconds, depending on your scanner type.
- Standby. The radar is on and is warmed up. It is ready to start transmitting immediately.
- Transmitting. The radar is actively sending and receiving microwave radio pulses. An open array will be rotating.

If you want to save on power but be able to start transmitting immediately, use standby mode.

18-3 Enabling the radar functionality

When the radar is enabled, it will turn on, warm up, and enter standby mode. The different radar modes are explained in Section 18-2.

To enable the radar functionality:

- 1 Press **MENU** twice to display the Setup menu, then select **System**.
- 2 Set Radar to .

- 3 The radar immediately turns on and enters warm-up mode. A message shows how long this will take.
- 4 When the warm-up period is complete, the radar enters standby mode and is ready to transmit. To start the radar transmitting, see Section 18-4.

18-4 Selecting standby mode or transmit mode

You can quickly change between these two modes.

1. From the radar window, press **MENU** and set the Transmit option to (transmit mode) or (standby mode).

18-5 Disabling the radar functionality

- 1 Press **MENU** twice to display the Setup menu, then select **System**.
- 2 Set Radar to .

- 3 A warning message appears. If you are sure that you want to disable the radar functionality, select **Yes**.
- 4 The radar enters disabled mode immediately.

18-6 Adjusting the quality of the radar window

Common problems that can degrade the quality of the radar window include:

- sea clutter
- rain clutter
- false echoes (sometimes called ghost echoes) and background noise
- side lobe patterns (false echoes that appear as an arc or a broken arc)

- shadows (blind spots)
- multiple echoes off the same object
- incorrect threshold setting

If the radar is installed at a suitable height and in a suitable location on your boat, side lobe patterns and shadows (blind spots) caused by obstructions such as funnels or masts will be minimized. If you're having problems with

these, you may need to relocate the radar. Consult the Installation Guide for your Northstar radar or talk to your dealer or installer.

Multiple echoes off the same object are most likely to occur when you are close to a large target and are usually only a temporary nuisance.

You can adjust the radar to reduce the effects of sea clutter, rain clutter, and interference from other radars. You can also change the gain mode setting and the gain level setting to help reduce false echoes.

- 1 From the radar window, press **MENU** then select **Presentation**.
- 2 Select **Adjust Radar** and press **ENTER**.

18-6-1 Changing the gain mode

Use the radar gain mode to specify whether

Adjust radar	
Gain Mode	Manual
Gain Level	25%
Sea Clutter Mode	Range rider
Sea Clutter Level	54%
Rain clutter	8%
Threshold	20%

you want to adjust the radar gain yourself or have it adjusted automatically.

To change the radar gain mode:

- 1 From the radar window, press **MENU** then select **Adjust Radar**.
- 2 Select **Gain Mode**. There are three choices:
 - **Manual**. Adjust the radar gain yourself to suit your local conditions and preferences.
 - **Auto**. The radar gain is adjusted automatically.
 - **Range rider**. Select this to adjust the radar gain yourself for a particular radar range, then have those settings stored and automatically re-used whenever you operate at that range again.

18-6-2 Changing the gain level

Use the radar gain level to adjust the sensitivity of the radar receiver. Ideally, the radar gain level should be set so that background noise is just visible on the radar window.

If the radar gain level is too low, weak echoes won't be shown. If the radar gain level is too high, strong echoes will be difficult to see amongst the large amount of background noise.

(If the radar Gain Mode is set to Auto and you adjust the gain level manually, the Gain Mode is changed to Manual.)

To change the radar gain level:

- 1 From the radar window, press **MENU** then select **Adjust Radar**.
- 2 Select **Gain Level** then use **←** and **→** to decrease or increase the setting.

18-6-3 Changing the sea clutter mode (Manual mode)

Sea clutter usually appears as confusing, random signals close to your boat on the radar window.

High waves that can reflect the radar signal will produce the maximum amount of sea clutter.

You can change the sea clutter mode yourself or have it changed automatically to compensate for the sea conditions.

To change the sea clutter mode:

- 1 From the radar window, press **MENU** then select **Adjust Radar**.
- 2 Select **Sea Clutter Mode**. There are four choices:
 - **Manual**. Adjust the sea clutter setting yourself.
 - **Harbour**. The sea clutter setting is adjusted automatically to suit a harbour environment.
 - **Offshore**. The sea clutter setting is adjusted automatically to suit an offshore environment.

- **Range Rider.** Adjust the sea clutter setting yourself for a particular radar range, then have those settings stored and automatically re-used whenever you operate at that range again.



18-6-4 Changing the sea clutter level

If the sea clutter level is set too low, a lot of sea clutter will be displayed. If the sea clutter level is set too high, small targets may not be shown in the radar window.

If the sea clutter mode is set to Harbour or Offshore, and you adjust the sea clutter level manually, the sea clutter mode changes to Manual.

If you are in Range Rider mode when you adjust the sea clutter level, the sea clutter mode does not change to manual but the setting is stored and used automatically whenever you use the same range again.

To change the sea clutter level:

- 1 From the radar window, press  then select **Adjust Radar**.
- 2 Select **Sea Clutter Level** then use  and  to decrease or increase the setting.



18-6-5 Changing the rain clutter

Rain clutter consists of random dots that can merge into badly-defined echoes on your radar screen.

The random signals are returned from rain, hail, sleet, or snow and can result in a confusing display.

If the rain clutter is set too low, there will be excessive rain clutter displayed whenever it's raining. If the rain clutter is set too high, very large targets such as the coastline will appear to be hollow.

To change the rain clutter setting:



- 1 From the radar window, press  then select **Adjust Radar**.
- 2 Select **Rain clutter** then use  and  to decrease or increase the setting.

18-6-6 Changing the threshold level

Use this to define the threshold level of the weakest echo that you want to show on the radar screen. The threshold level is shown as a percentage.

100% is the maximum threshold level, meaning that only the strongest echoes are shown. 0% is the minimum threshold level, meaning that all echoes are shown.

To change the threshold level:

- 1 From the radar window, press  then select **Presentation**.
- 2 Select **Threshold** then use  and  to decrease or increase the setting.

18-7 Changing the echo expansion setting

If you have several small targets in view and want to make them easier to see, use the echo expansion option. **Note** that the resolution decreases as the target size increases, so use this option only when target detection and visibility is more important than the quality of the display.

To change the echo expansion setting:

- 1 From the radar window, press  then select **Presentation**.
- 2 Select **Echo Expansion**. There are three choices:
 - **Off.** No echo expansion.
 - **1.** Targets expanded x 2.
 - **2.** Targets expanded x 3.

18-8 Turning the target trails on or off

If you turn the target trails on, each target leaves a 30 second trail on the radar screen. You cannot change the length of the target trail.

If you turn the target trails off, the targets do not leave trails.

Note that if the radar motion mode is set to true, stationary targets won't leave a trail. If the radar motion mode is relative, any target that is moving relative to your boat will leave a trail.

18-9 Using the VRM/EBL

Use one, or both of the VRM/EBL (Variable Range Markers/Electronic Bearing Lines) to quickly find the precise range and bearing of a target.

A VRM can be fixed or floating. Use the VRM to find the range (distance) to the target.

- A fixed VRM is shown as a thin, dashed, circle centred around your boat. Use this to find the distance of a target from your boat.
- You can move the centre of the VRM away from your boat; for example, to measure the distance between two islands. This is called a floating VRM.

The EBL is shown as a thin, dashed line extending from the centre of the VRM to the edge of the radar window. Use the EBL to find the bearing of the target.



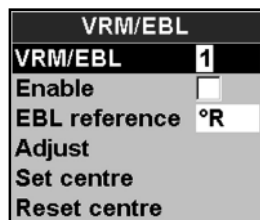



- 1 From the radar window, press  then select VRM/EBL.



To change the target trails setting:

- 1 From the radar window, press  then select Presentation.
- 2 Set the Target trails option to (target trails are on) or (target trails are off).

18-9-1 Finding range and bearing with a fixed VRM/EBL

- 1 From the radar window, press  then select VRM/EBL.
- 2 Select VRM/EBL then 1 (VRM/EBL 1) or 2 (VRM/EBL 2).
- 3 Set Enable to to show the VRM and EBL on the radar window (or to hide them).
- 4 Select EBL reference if you want to change the EBL bearing reference. There are two choices:
 - °R shows the EBL bearing relative to your boat's head.
 - °M/°T shows the EBL bearing relative to magnetic North or true North.
- 5 Select Adjust to change the positions of the VRM and the EBL so that you can align them with the target. Use:
 -  and  to decrease and increase the radius of the VRM until it touches the target to measure the range.
 -  and  to move the EBL until it touches the target to measure the bearing.
- 6 The range and bearing of the target is shown at the bottom of the screen.
- 7 If you want to hide (or change the settings for) the range rings, North line, and/or heading line, press  then select Radar.

- 8 To clear the VRM/EBL display, press ESC and repeat steps 1 and 2. Then set Enable to Γ .

If you want to find the range and bearing of another target, repeat the sequence using the other VRM/EBL. This is shown in a different pattern.

18-9-2 Finding range and bearing with a floating VRM/EBL

If you move the centre of a VRM away from your boat it is called a floating VRM. Use this to measure the range and bearing between two locations on the radar window, such as a headland and a buoy.

- 1 From the radar window, press MENU then select VRM/EBL.
- 2 Select VRM/EBL then 1 (VRM/EBL 1) or 2 (VRM/EBL 1).
- 3 Set Enable to \checkmark to show the VRM and EBL on the radar window (or Γ to hide them).
- 4 Select EBL reference if you want to change the EBL bearing reference. There are two choices:
 - °R shows the EBL bearing relative to your boat's head.
 - °M/°T shows the EBL bearing relative to magnetic North or true North.

- 5 Select **Set centre** to move the VRM and EBL centre away from your boat. Use the arrow keys to move the centre so that it is aligned over the first location.

- 6 Press **ENTER** to save the new centre position, then press **MENU** and reselect the VRM/EBL.

- 7 Select **Adjust** to change the positions of the VRM and the EBL so that you can align them with the second location. Use:

- \odot and \oplus to decrease and increase the radius of the VRM until it touches the second location to measure the range.
- \blacktriangleleft and \blacktriangleright to move the EBL until it touches the second location to measure the bearing.

- 8 The range and bearing of the target is shown at the bottom of the screen.

- 9 If you want to hide (or change the settings for) the range rings, North line, and/or heading line, press MENU then select Radar.

- 10 To clear the VRM/EBL display, press ESC and repeat steps 1 and 2. Then set Enable to Γ .

If you want to find the range and bearing between two other locations, repeat the sequence using the other VRM/EBL. This is shown in a different pattern.

18-10 Changing the PPI position

You can move the PPI (Plan Position Indicator) centre to a different location if you are in Relative motion mode. (If you are in True motion mode, the radar automatically positions the PPI centre.)

To change the PPI position:

- 1 From the radar window, press MENU then select Position.
- 2 There are three choices:
 - Centre. The PPI centre is in the centre of the radar window so that all other objects move relative to your boat.

- Look Ahead. The PPI centre is positioned so that the radar window is offset from the centre to give you the maximum view ahead.
- Set. Offset the PPI centre in the radar window. (This works only when you are using relative motion (RM) mode). Use the arrow keys to move the PPI centre to the new position then press **ENTER** to confirm. The new position must allow most of the radar sweep to appear on the radar window; if it doesn't, the PPI centre will be moved as close as possible to the desired position.

18-11 Using the radar guard zones

Use either or both of the two radar guard zones and alarms to notify you when a target enters or exits a specified area around your boat.

You can customize the size and shape of the radar guard zones and set up alarms.

Guard Zone	
Zone	1
Enable	<input type="checkbox"/>
Alarm when	Exit
Adjust	
Alarm sensitivity	0%

- 1 From the radar window, press MENU then select Guard zone.

18-11-1 Turning a radar guard zone on or off

Two radar guard zones are available. You can turn either or both on or off.

To turn a radar guard zone on or off:

- 1 From the radar window, press MENU then select Guard zone.
- 2 Select Zone. There are two choices:
 - 1 selects radar guard zone 1.
 - 2 selects radar guard zone 2.

18-11-2 Displaying the area covered by a radar guard zone

- 1 From the radar window, press MENU then select Guard Zone.
- 2 Select Zone then radar guard zone 1 or radar guard zone 2.
- 3 Set Enable to (show the radar guard zone) or (hide the radar guard zone).

18-11-3 Change the setting for a radar guard zone alarm

When a radar guard zone is on, the guard zone alarm is set automatically but you can change the setting to suit your preferences.

- 1 From the radar window, press MENU then select Guard Zone.
- 2 Select Zone then radar guard zone 1 or radar guard zone 2.
- 3 Select Alarm when. There are three choices:
 - Enter sounds the alarm only when a target enters the radar guard zone.
 - Exit sounds the alarm only when a target leaves the radar guard zone.
 - Both sounds the alarm when a target enters or leaves the radar guard zone.

18-11-4 Adjusting the boundaries of a radar guard zone

To adjust the boundaries and change the area that is covered by a radar guard zone:

- 1 From the radar window, press MENU then select Guard Zone.
- 2 Select Zone then 1 (radar guard zone 1) or 2 (radar guard zone 2).
- 3 Select Adjust to display the current boundaries of that radar guard zone. The following information is also shown in the top left corner:
 - Guard Zone The number shows the radar guard zone that is selected.
 - Sector or Circular The shape of the radar guard zone.
 - INR The distance between the inner boundary and your boat.
 - OUR The distance between the outer boundary and your boat.
 - WDT The angular width of the radar guard zone (in degrees).
 - BRG The bearing of a line drawn from your boat through the centre of the radar guard zone (in degrees).
- 4 Use ◀ and ▶ to select the parameter to change.
- 5 Then use ▲ and ▼ to change the parameter.

18-11-5 Adjusting the sensitivity of the alarm

You can set the sensitivity of the alarm for the radar guard zones, to define the size of the target that will trigger the alarm. The size of target is shown as a percentage.

100% is maximum sensitivity, meaning that very small targets will trigger the guard zone alarm. 0% is minimum sensitivity, meaning that only very large targets will trigger the alarm.

The same sensitivity setting is applied to both of the radar guard zones if both are turned on.

To set the alarm:

- 1 From the radar window, press MENU then select Guard Zone.
- 2 Select Zone then select 1 (radar guard zone 1) or 2 (radar guard zone 2).
- 3 Select Alarm sensitivity then use ◀ and ▶ to decrease or increase the setting.

19 Setting up the M121/M84

The M121/M84 has a number of advanced features which are set up through the setup menu. We recommend that you become familiar with the operation of the unit using the default settings before making any changes in these menus.

To go to a setup option menu, press **SETUP** (M121 only) or press **MENU** twice, to display the setup menu, then select an option.

Note:

- 1 The Setup menu options are explained in the following sections.
- 2 Section 2-1 describes how to set or change data in the setup menus.
- 3 The setup data available will depend on the optional sensors and instruments installed.

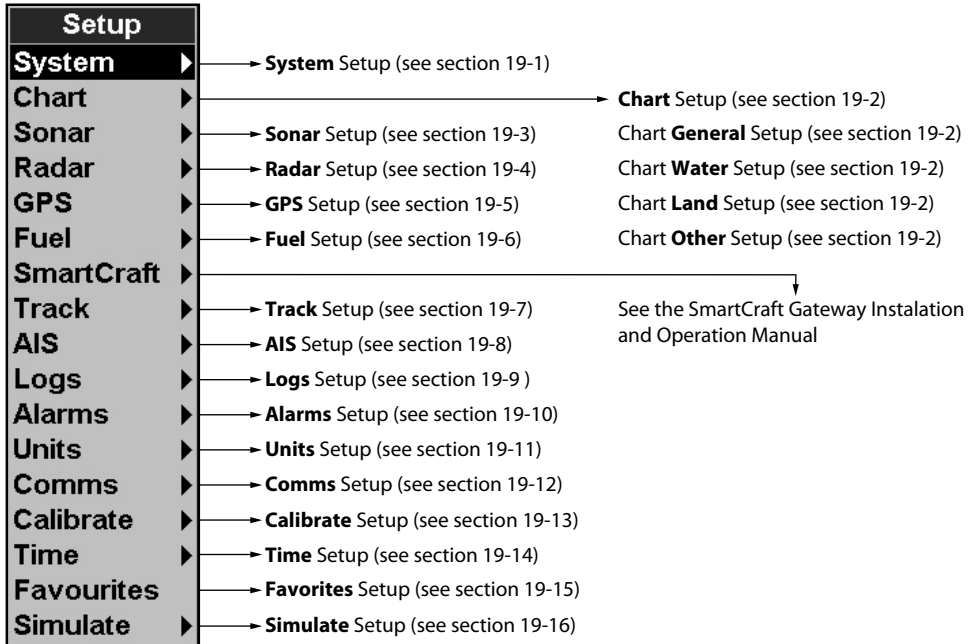

19-1 Setup > System

Press **MENU** twice, then select System:

System	
Language	English
Backlight	15
Night mode	<input type="checkbox"/>
Beep Volume	11
Key beep	Click
Auto power off	<input type="checkbox"/>
Screen snapshot	
Factory reset	
About	
<hr/>	
Sonar	<input checked="" type="checkbox"/>
Radar	<input checked="" type="checkbox"/>
SmartCraft	<input type="checkbox"/>
AIS	<input checked="" type="checkbox"/>
Buddy track	<input type="checkbox"/>

Language

Select the language for the windows. The options are: English, Italian, French, German, Spanish, Dutch, Swedish, Portuguese, Finnish and Greek.

Tip: In case you can't read the current language, the language setting is found at the top of the system menu.

Backlight

Select the backlight level for the keys and display (see also section 2-3)

Night mode

Night mode sets the palette for all windows

- Normal palette, for daytime
- All windows have a palette optimized for night time.

See also section 2-3. To change only the chart palette, see section 19-2.

Beep volume

Select the beep volume for key presses.

Auto power off

See section 2-2.

Factory reset

This option returns all of the Instrument settings (except the language, waypoints and routes) to the default factory settings shown on the setup menus.

About

The about window shows:

- The software version and date.
- The world chart version.
- Any card fitted.
- The number of waypoints, routes and tracks you have stored.
- Connector wiring information.

About	
Copyright © 2004-2006 Northstar	
Software	Debug: 1.0.290, Sep 7 2006
Hardware	O.C.18.10
Bootloader	0.0.0
Cartography	7.0.8.25R
SmartCraft	..
<hr/>	
World chart	World Wide Background (CF95W02) 1.67
Slot 1	No card
Slot 2	No card
Waypoints	3000 51 Used
Routes	25 10 Used
Tracks	5 1 Used
<hr/>	
Powercomms cable	<input checked="" type="checkbox"/> Black
1	Black Ground
2	Brown +5V out
3	White NMEA out
4	Blue NavBus-
5	Red +120V in
6	Orange NavBus+
7	Yellow Ignition
8	Green Ext Alarm
<hr/>	
GPS cable	<input type="checkbox"/> Yellow
1	Black Ground
2	Red +5V out
6	Green NMEA from GPS
<hr/>	
Fuel cable	<input type="checkbox"/> White
1	Black Ground
3	White NMEA in
<hr/>	
Sonar cable	<input checked="" type="checkbox"/> Blue

In the unlikely event of having to contact a Northstar dealer for service, quote the software version number and date.

Sonar

- Disable any sonar transducer and disable sonar functions.
- A sonar transducer is fitted. Enable sonar operation.

See section 19-3.

Radar

- No appropriate Radar system is fitted. Disable RADAR.
- An appropriate Radar receiver is fitted. Enable AIS.

See section 19-4.

SmartCraft

- No SmartCraft gateway is fitted. Disable SmartCraft functions.
- SmartCraft gateway is fitted. Enable SmartCraft operation.

See section 20-8.

AIS

- No appropriate AIS receiver is fitted. Disable AIS.
- An appropriate AIS receiver is fitted. Enable AIS.

See section 19-8.

Buddy track

- No appropriate Northstar DSC VHF radio is fitted. Disable Buddy track.
- An appropriate Northstar DSC VHF radio is fitted. Enable Buddy track.

See section 20-10

19-2 Setup > Chart

Press **MENU** twice, then select Chart:

Chart	
Rotation	North up
Palette	Normal
Map datum	WGS-84
NMEA datum offset	<input checked="" type="checkbox"/>
Map shift	Off
General	▶
Water	▶
Land	▶
Other	▶

General	
Plotter mode	<input checked="" type="checkbox"/>
Mixing levels	<input type="checkbox"/>
AntiClutter	<input type="checkbox"/>
Value added data	<input type="checkbox"/>
Projected course	2 min
CDI scale	0.2 nm
Lat/lon grid	<input type="checkbox"/>
Boundaries	Auto
Text/icon Size	Small

Water	
Water features	<input checked="" type="checkbox"/>
Bathymetric lines	<input checked="" type="checkbox"/>
Spot soundings	<input checked="" type="checkbox"/>
Bath & sndgs min	0 m
Bath & sndgs max	15 m
Tidal Stream	<input checked="" type="checkbox"/>

Land	
Land features	<input type="checkbox"/>
Land elevation	<input checked="" type="checkbox"/>

Other	
Waypoints	Selected
Names	<input checked="" type="checkbox"/>
Lights	On
Nav-aids	INT
Attention areas	<input checked="" type="checkbox"/>

Rotation

The options for chart rotation are:

North up: North is always at the top of the chart window.

Track up: The chart is rotated so that the boat direction is to the top of the window. This option is useful for navigating narrow harbours or rivers. The Instrument asks for a course deviation resolution; this is how much the boat direction needs to change to make the chart redraw.

Tip: If the chart redraws too frequently, increase the course deviation setting.

Course up: This option is only available if the boat is navigating to a destination. The chart is rotated so that the plotted course to the destination is vertical.

Palette

Select the color scheme for the LCD window.

The options are:

Normal

Sunlight: Brighter colors, more visible in sunlight.

Night: Reversed colors for night, to preserve night vision.

Map datum

Instrument GPS positions are based on a worldwide reference (datum) known as WGS 84. Most paper charts are based on WGS 84. However, some paper charts are based on other datums. In these cases, the latitude and longitude coordinates of objects on the Instrument chart window are different to the latitude and longitude coordinates of these objects on the paper chart. This applies to all objects, such as the boat, waypoints, tracks, lines of latitude and longitude and cartographic features such as land, rocks, buoys and depth contours.

Use **Map datum** to select the Instrument map datum to match the datum of the paper chart. Then, the latitude and longitude coordinates of objects displayed on the Instrument will change to match the corresponding coordinates on the paper chart.

Setting map datum

- 1 In the Chart setup menu, select **Map datum**.
- 2 Select the map datum for the paper chart you are using.
- 3 If you select a datum other than WGS 84 the Instrument asks if you want to apply the NMEA datum offset (see below).

WARNING

When you change to a chart with a different datum, change the Instrument map datum again.

NMEA datum offset

If you select a map datum other than WGS 84, the map datum offset can be applied to latitude and longitude coordinates sent on the Instrument NMEA output:

☐ Latitude and longitude coordinates displayed on any NMEA repeater do not match the coordinates on the Instrument. Latitude and longitude coordinates broadcast on any NMEA VHF transmitter will be the same as the coordinates on a WGS 84 chart.

☑ Latitude and longitude coordinates displayed on any NMEA repeaters match the coordinates on the Instrument. However, latitude and longitude coordinates broadcast on any NMEA VHF transmitter will be slightly offset from coordinates on a WGS 84 chart.

Map shift

WARNING

Map shift is for eliminating minor offsets. It should not be used if the correct datum is available. Use map shift with caution: incorrect application will cause incorrect boat positions.

Some charts have consistent position errors. To correct this, apply a map shift. After a map shift:

- The positions of cartographic features (such as land, rocks, buoys and depth contours) move on the Instrument chart window to where they should be.
- The positions of the boat, waypoints, tracks, and lines of latitude and longitude on the Instrument chart window remain unchanged.

Applying a map shift

- 1 Move the boat to a known point on the chart, for example a marina berth.
- 2 In the Chart setup menu, select **Map shift**.
- 3 Move the cursor to the position on the chart where the boat actually is.
- 4 Press **MENU** and select **Set**.
- 5 Press **ESC** to set the new map shift. The boat will now be displayed at its actual location.

Clearing the map shift

Clearing the map shift removes any map shift from the cartographic features on the Instrument chart window.

- 1 In the Chart setup menu, select **Map shift**.
- 2 Press **MENU** and select **Clear**.
- 3 Press **ESC**.

General submenu

Plotter mode	<input type="checkbox"/> Only scales available on the chart card can be displayed. <input checked="" type="checkbox"/> If you press + or - to select a chart scale which is not available, on the chart card, the chart window will change to this scale but will only display the boat position and track (if enabled). The rest of the window is white with black crosshatch lines and no chart information is displayed. This is useful to zoom to a small scale to track small boat movements or if there is no detailed chart for an area.
Mixing levels	Mixes lower detail charts with higher detail charts on chart boundaries. <input type="checkbox"/> :Lower detail chart is not shown. <input checked="" type="checkbox"/> :Lower detail chart shown; this is slower to redraw.
Anticluttr	<input type="checkbox"/> Names and icons shown. Note: this is independent of the change in detail shown at different zoom levels. <input checked="" type="checkbox"/> Hides some less important names and icons when they overlap to make the chart clearer.
Value added data	<input checked="" type="checkbox"/> Non marine chart data shown
Projected course	The Instrument can estimate the course after a given time, based on the current speed and heading (see section 3-4). The options are 2 minutes, 10 minutes, 30 minutes, 1 hour, 2 hours or Off.
CDI scale	See Appendix C. The options are 0.05, 0.1, 0.2, 0.5, 1.0, 2.0, 4.0 and 10.0 distance units.
Lat/lon grid	<input checked="" type="checkbox"/> displays a latitude and longitude grid.
Boundaries	Displays boundaries around areas where more detailed chart coverage is available: Auto shows the next four detail levels; On shows all.
Text/icon size	Select the size of chart text and icons.

Water submenu

Water features	<input checked="" type="checkbox"/> displays nature of sea bed (for example, M shows areas of mud) and tide station icons.
Bathymetric[s] lines	Displays underwater depth contours between Bath & dndgs min and max.
Spot soundings	Displays underwater depth contours between Bath & dndgs min and max.
Bath & sndgs min	The minimum depth for Bathymetrics and Spot soundings.
Bath & sndgs max	The maximum depth for Bathymetrics and Spot soundings.
Tidal stream	<input checked="" type="checkbox"/> displays dynamic tide flows: arrows on a chart showing the present tide stream and orientation (requires a GPS fix and an NT-MAX card)

Land submenu

Land features	<input checked="" type="checkbox"/> displays land features, for example regions, rivers, roads, railways, airports.
Land elevation	<input checked="" type="checkbox"/> displays land contours, shaded like depths (requires an NT Max card)

Other submenu

Waypoints	Displays waypoints: Hide all only displays waypoints on any selected route; Selected displays waypoints with their display option set to Icon or I+N (Icon and Name); Show all displays all waypoints (see section 5).
Names	<input checked="" type="checkbox"/> displays place names.
Lights	Light House window options: Off hides all light indicators (the icon still shows); No sectors hides sectors; On shows sectors; Animated activates light animation. Note: with light animation enabled, animation only operates chart.
Nav-aids	Displays signals (fog, radar, radio stations) and buoys. Int and US select the icon format; Simpl draws simpler icons.
Attention areas	<input checked="" type="checkbox"/> displays attention area boundaries and information icons  ; attention areas are important areas, such as restricted anchorages or shallow areas.

19-3 Setup > Sonar

Press **MENU** twice, then select Sonar:

Sonar	
Frequency	200kHz
Scroll speed	Fast
Fish symbols	Off
Fish depth labels	<input type="checkbox"/>
Fish filter	Small
Fish sensitivity	Medium
Digit size	Medium
Palette	White
Interference filter	<input type="checkbox"/>
Noise filter	Off
Surface clutter filter	<input checked="" type="checkbox"/>
Pulse length	Auto
Pulse power	Auto

Frequency

There is a choice of: 200 kHz, 50 kHz and Mixed. For information about selecting a suitable frequency for the water conditions, see section 9-3.

Scroll speed

Use this to set the scroll speed on the display. There is a choice of: Very Fast, Fast, Medium, Slow and Pause. The depth of the water also affects the speed of the display. Faster scroll speeds combined with a slow boat speed (typically between 2 and 6 knots) shows the most fish detail. Medium or Slow scroll speeds result in sonar information being displayed over a longer period, but with less detail (see Section 9-2).

Fish symbols

The Instrument always displays echoes from fish (fish arches, see section 9-4). If fish symbols are on, a symbol is displayed over the arch (see section 9-4). The options are:

- **Off**: No fish symbol is displayed.
- **Fun or Normal**: A fish symbol is displayed.

Fish depth labels

When this is turned on, the depth of a fish is printed next to the fish arch.

Fish filter

Use this to select the minimum fish size that will be displayed as a fish symbol and to trigger the Fish alarm. The options are: Small, Medium and Large.

Fish sensitivity

Selects the minimum strength fish echo that will be displayed as a fish symbol. Higher values will display more fish symbols.

Digit size

Use this to remove or change the size of the depth window on the sonar windows. There is a choice of: Small, Medium and Large.

Palette

Use this to select a color palette. Each color within the palette represents a different echo strength, as shown on the sonar windows.

There is a choice of five color palettes: Black, Blue, White, Vivid and 8 color. The first four palettes display more detail, and each color covers a 1.5 dB signal range. The 8 color palette displays less detail, and each color covers a 3 dB signal range.

Interference filter

- No filter, normal setting.
- Filters the echo signal to remove spiky interference such as engine noise or depth sounders on nearby boats.

Noise filter

Averages the echo signal to remove rapid changes. Select Medium or High to give a smoother bottom trace—this may help to detect a deeper bottom; however these settings may also remove fish echoes. Select Off for best fishfinding.

Surface clutter filter

Use this filter to hide the surface noise. Any significant echoes (such as fish) will still be displayed.

Pulse length

This can be used to specify the length of the transmitted ultrasonic pulse. A short pulse length improves the window detail but contains less energy, therefore it does not penetrate as deeply into the water as a longer pulse.

There is a choice of **Auto**, **Short**, **Medium** or **Long**. The **Auto** setting is recommended.

Pulse power

This can be used to specify the power output of the transmitted ultrasonic pulse. Low power output conserves the battery and produces a clear display in shallow water.

There is a choice of **Auto**, **Low**, **Medium** or **High**. The **Auto** setting is recommended.

19-4 Setup > Radar

Note: This option is shown only when the radar is enabled (see Section 18-3)

- 1 Press MENU twice to display the Setup menu, then select Radar:

Radar	
Rotation	Head Up
Motion mode	Relative
Interference filter	Off
Palette	Green
Digit size	Small
Range ring	<input checked="" type="checkbox"/>
North line	<input checked="" type="checkbox"/>
Heading line	<input checked="" type="checkbox"/>
Installation	

Rotation

The current radar rotation is shown in the top left corner of the radar screen. If COG data or heading data is not available from a compass, the radar rotation is automatically set to Head up.

However, you are strongly recommended to use a good quality product (such as a Northstar HS02, HS03 or Autopilot) to provide heading data.

If heading data is available from a compass, the options are:

- North up works only when COG data or heading data from a heading sensor is available. North is always at the top of the radar screen. You can easily compare the radar screen to a chart in North up.
- Head up means that the radar image rotates underneath your boat, so the direction in which you are heading is pointing to the top of the radar screen. You can easily compare the visual view in front of your boat with the radar screen.

- Course up works only when COG data or heading data from a heading sensor is available and there is an active route. It means that your desired heading is always pointing to the top of the radar screen so that you can compare the leg bearing of the active route with the radar screen. (If you're in Course up rotation but don't have an active route, the radar uses Head up rotation until a route is made active.)

Motion mode

True motion mode is not available if there is no position data, and no heading or COG data. However, you are strongly recommended to use a good quality product (such as a Northstar HS02, HS03 or Autopilot) to provide heading data.

There are two choices:

- Relative (RM). Your boat remains in a fixed location on the radar screen and all other objects move relative to your position. (You can choose the position of the fixed location, see Section 18-10). RM is the default.
- True (TM). Your boat, and moving targets, move across the radar screen as you travel. All stationary objects remain in a fixed position. You must have position data, and heading or COG data for this option to be available.

Interference filter

If the radar on another boat is operating at the same frequency as your radar, it can cause interference patterns on the radar window.

Interference patterns always appear in a different place with each sweep. They can be randomly scattered bright dots or dotted lines that extend from the centre to the edge of the radar window, often producing a spiral pattern. Generally, the stronger the interference, the wider the interference lines.

Use the interference rejection option to reduce both the interference patterns and the width of the interference lines.

There are four choices:

- Off. Interference rejection is off.
- Low operates the interference rejection at minimum strength.
- Medium operates the interference rejection at medium strength.
- High operates the interference rejection at maximum strength. This setting can make it more difficult to detect some targets and radar beacons. Use this setting only when necessary.

Palette

Select the color scheme for the radar window.

Digit size

The range of the radar is shown on the radar window; for example 1/16. You can show this information in small, medium or large digits.

Range ring

The range rings and compass ring help you to quickly estimate the range and bearing of a target from your boat.

The range ring and compass ring are shown.

The number of range rings and the spacing interval between them is set automatically according to the range setting. The current spacing interval is shown in the top left corner of the radar window.

Range ring and compass ring are hidden.

North line

Whatever the radar window rotation, you can always show the blue North line.

If the bearing mode is set to:

- magnetic, the North line always points to magnetic North.
- true, the North line always points to true North.

Show the North line.

Hide the North line.

Heading line

The heading line is a white line that extends from your boat to the edge of the radar window.

Show the heading line.

Hide the heading line.

19-4-1 Setup > Radar > Installation

Note: This option is shown only when the radar is enabled (see Section 18-3)

- 1 Press MENU twice to display the Setup menu, then select Radar.
- 2 Select Installation:

Installation	
Park position	0.0 °
Zero bearing	0.0 °
Zero range	0.0 m
Antenna height	0.0 m

Park position

If your radar has an open array and you take it out of enabled mode, the open array continues to rotate for a short distance before it finally stops. The stop position is known as the park position. You can adjust the angle of the parking position so that the open array will always stop at your preferred position; for example, facing the bow.

- 1 Select Park position then enter the angle of the new park position.

Note: You may need to try a few different park positions to find the correct one. The strength of the wind will also affect the park position.

Zero bearing

Use the zero bearing alignment to rotate the radar image, one degree at a time, so that a known object dead ahead is directly under the boat's heading marker.

This means that the radar image is aligned with the displayed chart and the compass. An accurate bearing alignment is particularly important when the radar image is overlaid onto the chart.

Adjust this on a chart window with the radar overlay on.

- 1 Select Zero bearing then use the arrow keys to enter the new bearing angle.

Zero range

The zero range is also known as the radar range offset and as the trigger delay.

If your radar window shows a blank, black circle around the centre or a solid circle of color at the centre, you need to adjust the zero range setting until this circle disappears or almost disappears. Ideally, the radar sweep should start at your boat (a radar range of zero).

To adjust the zero range setting:

- 1 Position your boat about 45 to 90 m (50 to 100 yards) away from and parallel to a straight-walled jetty or similar feature.
- 2 Adjust the gain setting if necessary, so that a reasonably good image of the jetty echo is displayed on the radar window. At this stage, the jetty echo may appear to be bent.
- 3 Select Zero range then use the arrow keys to adjust the zero range setting until the jetty echo appears as a straight line on the radar window.

Antenna height

The Installation Manual for your Northstar radar explains how to find the optimum height for your radar scanner (antenna).

Select Antenna height then enter the height of the antenna above sea level.



19-5 Setup > GPS

Press  twice, then select GPS:

GPS	
GPS source	NMEA
DGPS source	WAAS/EGNOS
Restart GPS	
Static navigation	Off
Speed filter	5
Course filter	4

GPS Source

- **NMEA:** Use the external GPS antenna supplied or an external GPS or DGPS source connected via NMEA (see section 20-11).
- **NavBus:** Use an external GPS or DGPS source connected via NavBus (see section 20-10).

DGPS Source

Refer to section 20-5

Restart GPS

Refer to section 20-5

Static Navigation

When the boat stops or moves very slowly, the calculated GPS speed and course become erratic. Static navigation allows the erratic values to be filtered:

- 0.01 to 99.9: If the boat speed is slower than this, the speed is displayed as zero and the course stays unchanged.
- 0 (Off): The calculated speed and course are always used.

Speed and Course Filter

Waves and wind cause the boat speed and course to fluctuate slightly. To give stable readings, the Instrument calculates these values by taking several measurements and averaging them.

- A lower value averages measurements over a shorter period of time. This gives the most accurate value but has the most fluctuations.
- A higher

19-6 Setup > Fuel

Fuel functions require optional fuel flow sensors to be installed. Press **MENU** twice, then select Fuel:

Fuel	
Source	Petrol
Num engines	2
Num tanks	2
Setup engines	▶
Setup tanks	▶
Diesel sensors	
Fuel consumption curve	▶
Speed source	Ground speed
Max fuel flow	1 G
Max RPM	7000

WARNING

Fuel consumption can change drastically depending upon the boat loading and the sea conditions. Always carry adequate fuel for the journey, plus a reserve.

Source

Select the fuel flow sensors to use if the boat has more than one set of fuel sensors. Normally select **Auto**.

Num engines

Set the number of engines, or select 0 to disable the fuel functions. If there are two engines they are called port and starboard.

Num tanks

Set the number of fuel tanks. If there are two tanks they are called port and starboard.

Setup engines

If the boat has more than one engine, select **Engine** and select each engine in turn.

For the selected engine, you can enter:

Setup engines	
Engine	Single
From tank	Single
Calibrate	
Flow filter	5
Clear used	
Used	0.0 G

From tank: The fuel tank the engine is connected to.

Flow filter: Most engines do not draw fuel from the tank at a steady rate. To give a stable fuel flow reading, the M121/M84 calculates the flow by taking several measurements and averaging them. Use the Flow filter to set the period over which the fuel flow is averaged.

The Flow filter can be set from 0 to 30 seconds. Use the lowest value which gives a stable flow. Usually a value of 5 to 10 seconds will give a satisfactory result for two-stroke carburetor engines. Fuel injected or four-stroke engines may require a larger value.

This setting affects the Fuel flow and Fuel economy reading on the Fuel display but it does not affect the Fuel used reading.

Setup tanks

If the boat has more than one tank, select **Tank** and select each tank in turn.

For the selected tank, you can enter:

Setup tanks	
Tank	Single
Add fuel	
Fill tank	
Set remaining	0 G
Tank alarm	<input type="checkbox"/>
Tank alarm	Off
Tank size	0 G

Tank size: The tank capacity. Northstar recommends measuring tank size by draining the fuel tank, filling it to capacity and using the fuel dispenser's reading. Beware of air pockets, especially in underfloor tanks.

Fuel alarm: See section 13-4.

Fuel consumption curve

See section 13-6.

Speed source

If both water speed and ground speed are available, select which to use for fuel calculations (see section 10-5-1).

Max fuel flow

The maximum fuel flow from a fuel tank to be displayed on an analog fuel flow gauge (see section 8)

Max RPM

The maximum engine RPM to be displayed on an analog RPM gauge. Required only if Northstar diesel flow sensors are installed. Enter the maximum RPM you know you can achieve for the engine rather than the maker's value.

19-7 Setup > Track

Press **MENU** twice, then select **Track**:

Track	
Record	1
Display	1
Plotting interval	Distance
Distance	0.5 nm
Time	10 sec
Memory used	68%
Send track	
Delete track	

Tracking records and displays the boat's course on the chart (see section 3-5). Five different tracks can be recorded: track 1 has up to 2000 points and tracks 2, 3, 4 and 5 have up to 500 points each.

Record

OFF: The Instrument stops recording a track.

1 to 5 (select a track number): The Instrument starts recording the boat's course into the selected track.

Display

OFF: No track is shown on the chart.

1 to 5 (select a track number): The selected track is shown on the chart.

Plotting Interval

Select the plotting and recording interval. The options are *Distance* or *Time*.

Distance

Select the distance plotting interval: 0.01, 0.05, 0.1, 0.5, 1.0, 2.0, 5.0 or 10.0 distance units.

Time

Select the time plotting interval: 1, 5, 10 or 30 seconds or 1 minute.

Memory used

The percentage of memory used in the track being recorded.

Tip: Use the user card window to check the number of points recorded in each track (see section 15).

Send track

This option is included for compatibility with older units. For information, see your Northstar dealer.

Delete track

The data in the track selected for Record (see above) is deleted.

19-8 Setup > AIS

Note: This feature requires an AIS receiver.

There are multiple methods to filter AIS vessels that are displayed onto the charts.

AIS	
Filter by type	▶
Filter by distance	556 km
Filter by speed	0 kn
Show dangerous only	<input type="checkbox"/>
Dangerous vessel alarm	<input checked="" type="checkbox"/>
TCPA limit	2 min
CPA limit	0.2 km
Projected course	Off
Range rings	0
Proximity alarm	<input checked="" type="checkbox"/>
Proximity radius	0.02 km

Filter by Type

Vessel types that are not selected will be filtered off the chart. Default is set to all types enabled allowing all vessels to be displayed on the chart.

Filter by distance

Vessels outside the radius selected from our current position are filtered off the chart. Default value is set to 300 nm allowing all vessels to be displayed on the chart within that distance.

Filter by speed

Vessels with speed below the value selected are filtered off the charts. Default is set to 0 nm allowing all vessels to be displayed onto the chart.

Show Dangerous Only

Show only vessels that have a TCPA/CPA below the trigger values. This filter will override any other filter option.

Dangerous Vessel Alarm

When enabled an alarm will activate when both the TCPA and CPA are less than the trigger values.

Note: Even when this setting is disabled the dangerous vessels will still be indicated on the chart.

TCPA Limit

Set the Time of Closet Point of Approach limit.

CPA Limit

Set the Closet Point of Approach limit.

Projected Course

Show the estimated course of all vessels based on their current SOG and COG.

Range Rings

Show a selectable number of range rings around the boat. The rings are drawn in multiples of the current chart scale.

19-9 Setup > Logs

Press  twice, then select Logs:

Logs	
Reset trip dist	
Reset total dist	
Reset engine hours	
Trip dist	0.00 nm
Total dist	0.00 nm
Engine hours	0.0 hrs

Proximity Alarm

When enabled an alarm will activate when any AIS vessel is within the proximity alarm radius.

The values can be reset independently of each other. These log values are saved when the unit is turned off.

Reset trip dist

This resets the trip distance to zero.

Reset total dist

This option resets the total distance to zero.



Reset engine hours

Use this option to reset the engine hours to zero. This can be useful after an engine service or to count the engine hours between service intervals.

19-10 Setup > Alarms

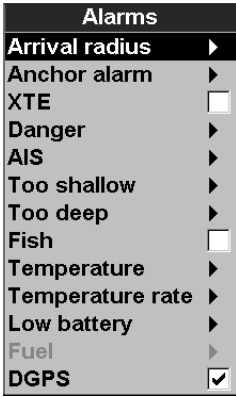













Press  twice, then select **Alarms**:



For all alarms select  to turn the alarm on or select  to turn the alarm off. For most alarms there is a trigger value. The alarm will sound each time the alarm value equals the trigger value.

For example, the **Danger** alarm will sound if the boat comes closer to a danger waypoint than the trigger value and the **Anchor** alarm will sound if the boat moves by more than the trigger value.

You can display the alarm status in the data header (see section 2-7-3). The alarm status shows the symbol for each alarm that is on. The symbol is normally black and turns red if the alarm triggers.

Symbol	Alarm	Beeper	Alarm sounds when it is on and the:
	Arrival radius		Boat is closer to the destination or to a waypoint than the alarm trigger value
	Anchor alarm		Boat moves by more than the alarm trigger value
	XTE		Boat moves off course by more than the CDI scale (see section 5)
	Danger		Boat comes closer to a danger waypoint than the alarm trigger value
	Too shallow	1/5 sec	Depth is less than the alarm trigger value
	Too deep	1/2 sec	Depth is greater than the alarm trigger value
	Fish	1 short beep	Echo matches the profile of a fish
	Temperature	1/2 sec	Temperature equals the alarm trigger value
	Temperature rate	1/2 sec	Rate of change of temperature equals the alarm trigger value
	Low battery	1/2 sec	Battery voltage is less than the alarm trigger value
	Low fuel	1/2 sec	Low fuel remaining equals the alarm trigger value; on a multitank boat you can set separate alarms for each tank (see section 13-4)
	Loss of DGPS fix		Instrument can not receive the DGPS signal (beacon, WAAS or EGNOS)
	Loss of GPS fix		Instrument can not receive the GPS signal (this alarm is always on)
	Loss of AIS receiver communication		M121/M84 is no longer receiving communication from the AIS receiver (Alarm is on when AIS is enabled)
	Dangerous vessel		The TCPA/CPA of another vessel is less than the trigger values (see section 13)

19-11 Setup > Units

Press **MENU** twice, then select Units:

Units	
Distance	km
Distance small	ft
Speed	kn
Depth	ft
Fuel	USGal
Compass	°M
Temperature	°F
Wind	TRUE
Pressure	kPa
Baro	mB

The default units are shown above.

Distance

nm (nautical miles), mi (miles) or km (kilometers)

Distance small

ft (feet) or m (metres)

Speed

kn (knots), mph (miles per hour) or kph (kilometers per hour)

Depth

ft (feet), m (metres) or fa (fathoms)

Height

ft (feet) or m (metres)

Fuel

Litres, USGal (US gallons) or ImpGal (Imperial Gallons)

Compass

°T (True north) or °M (Magnetic north)

Temperature

°F (Fahrenheit) or °C (Celsius)

Wind (optional)

Requires a wind instrument: True or App (Apparent)

Note: that the units for wind speed are the speed units.

Pressure

Requires SmartCraft: kPa or psi

Baro (Barometric pressure)

Requires a Northstar VHF receiver with barometer connected by NavBus: InHg or mB.

19-12 Setup > Comms

Use this feature when the Instrument is connected to other Northstar instruments through NavBus or any compatible NMEA instrument.

Press **MENU** twice, then select Comms:

Comms	
NMEA out	<input type="checkbox"/>
NMEA data	▶
Lat/Lon d.p's	3
NavBus	<input checked="" type="checkbox"/>
NavBus group	0

NMEA out

NMEA is generally used with third party instruments (see section 20-12). Select this to transmit NMEA sentences, for example to an autopilot.

NMEA data

Use this to specify which NMEA sentences will be transmitted (see section 20-12 and Appendix A).

Lat/lon dps

Select the number of decimal points used for latitude and longitude transmitted in NMEA sentences.

NavBus

NavBus is the preferred method for connecting the Instrument to other Northstar instruments. Select this if the instruments are connected using NavBus.

NavBus Group

Use this when a group of Northstar instruments are connected together using NavBus, to specify a group of instruments for backlighting, if required. Then, if the backlight setting on one instrument in the group is adjusted, the other instruments change automatically. Otherwise, select 0. See section 20-10.

19-13 Setup > Calibrate

Press **MENU** twice, then select Calibrate:

Calibrate	
Speed	
Speed filter	Off
Temperature	
Temp filter	5 sec
Keel offset	0.0 ft
Speed range	Low

Speed

This calibrates the speed from a paddlewheel sensor connected to the Instrument. Calibration may be required because different hull shapes have different flow characteristics. Obtain an accurate measurement of the boat's speed from a GPS receiver; or by following another boat travelling at a known speed; or by making a timed run over a known distance.

Note: for accurate calibration:

- The speed from a GPS receiver should be greater than 5 knots.
- The speed from another paddlewheel transducer should be between 5 and 20 knots.
- Best results are achieved in calm conditions where there is minimal current (best at high or low tide).

Calibrating speed:

- 1 Travel at a constant, known speed.
- 2 In the Calibrate menu, select Speed.
- 3 Press **←** or **→** to change the displayed speed to the true value.
- 4 Press **ENTER**.

Speed filter

Waves and wind cause the boat speed from the paddlewheel transducer to fluctuate slightly. To give stable readings, the Instrument calculates these values by taking several measurements and averaging them. Set the Speed filter to the lowest value which gives stable readings. The range is 1 to 30 seconds or Off (0).

Temperature

The factory settings should be sufficiently accurate for normal usage. To calibrate the temperature readout, first measure the water temperature with a thermometer known to be accurate.

Use the cursor keys to display the temperature readout box, then increase or decrease the value to match the measured temperature. The temperature can be set from 32° to 99.9°F (0° to 37.7°C) with a resolution of 0.1° unit.

To change the units between °F (Fahrenheit) or °C (Celsius), see section 19-11.

Temperature filter

Water turbulence and currents cause the water temperature to fluctuate slightly. To give stable readings, the Instrument calculates these values by taking several measurements and averaging them. Set the Temperature filter to the lowest value which gives stable readings. The range is 1 to 30 seconds or Off (0).

Keel Offset

A depth transducer measures depths below where the transducer is mounted on the boat, usually the bottom of the boat. The Instrument calculates the depths to display by adding the keel offset to all measured depths.

- A** Have a zero keel offset to display depths below the transducer.
- B** Enter a positive keel offset to increase the displayed depth. For example to display the total depths below the surface, enter the depth of the transducer below the surface.
- C** Enter a negative keel offset to decrease the displayed depth. For example, to display the depths of clear water below the boat, enter minus the depth of the deepest part of the boat below the transducer.

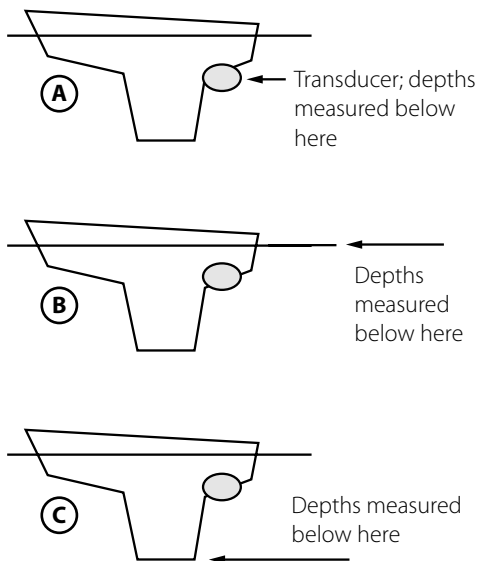

Speed range

The maximum reading to display on an analog boat speed gauge (see section 11). Choose a range suitable for your boat.

Fuel

See section 13-7, Calibrate.

19-14 Setup > Time

Press **MENU** twice, then select Time:

Time	
Local offset	+00:00
Time format	24 hour
Date format	dd/MMM/yy

Local offset

The difference between local time and UTC (GMT). Change local offset when daylight saving time starts and ends. The range is 0 to \pm 13 hours, in 30 minute steps.

- 1 Select Local offset.
- 2 Press **▲** or **▼** to change the offset, then press **ENTER**.

Time format

The options are 24 hour or 12 hour.

Date format

The options are dd/MMM/yy, MMM/dd/yy, dd/MM/yy or MM/dd/yy.

19-15 Setup > Favorites

Favourites	
Name	
1	Chart
2	Sonar
3	Chart + Sonar
4	Chart + Gauges
5	Radar
6	-
ENTER to save	

See section 2-7-2.

19-16 Setup > Simulate

Simulate mode is a way of becoming familiar with the Instrument (see section 2-6).

Press **MENU** twice, then select Simulate:

Simulate	
Simulate	<input type="checkbox"/>
Mode	Normal
Speed	6.0 kn
Course	221 °M
Route	AKLDEMO

Simulate

- Turn simulate mode off
- Turn simulate mode on

WARNING

Never have simulate mode on when the Instrument is navigating on the water.

Mode

There are two choices for Mode:

1 Normal

Simulates the boat moving from the selected start point at the given speed and heading.

The options required for Normal are:

Speed: The simulated boat speed to use.

Course: The simulated course over ground.

Note: To select the start point, go to the chart window before starting the simulation. Then:

- To start the simulation from the boat position, press **ESC** to switch to centre on boat mode.
- To start the simulation from a different point, move the cursor to that point on the chart.

Tip: To calculate a course, use the cursor (see section 3-2-1).

Tip: As the boat moves, vary Course to simulate the boat moving off course.

2 Demo

Simulates a boat moving along a route and automatically displays different Instrument functions. The options required for Demo are:

Speed: The simulated boat speed to use.

Route: The route to follow.

20 Installation

WARNING

Ensure that any holes cut are in a safe position and will not weaken the boat's structure. If in doubt, consult a qualified boat builder.

CAUTION

















Do not mount any part where it can be used as a hand hold, where it might be submerged or where it will interfere with the operation, launching or retrieving of the boat.

To help ensure proper operation, do not mount any part or cable within 0.5 m (20") of the plane of a radar antenna or within 1 m (3 ft) of a compass or source of electrical noise, such as engines, fluorescent lights, and power inverters.

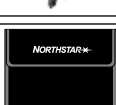
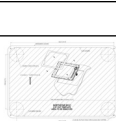
When fitting a cable, do not crush or strain the cable. Secure the cable at regular intervals. Ensure no connectors or exposed terminals are in wet area.

If the cables supplied are too long, do not shorten the cable; instead coil the cable. Most cables can be extended with Northstar extension cables. Do not fit more than one extension cable.

20-1 Installation: What else comes with my M121/M84?

Northstar GPS 124 Antenna	
GPS 124 Antenna bottom cone	
GPS 124 Antenna gasket	
GPS 124 mounting kit	
Sun cover for display unit Note: Place over display when not in use	
Front Bezel Note: Fit this after installing the display unit	
Power cable	
Mounting bracket and locking knobs	
Bracket mounting screws (5 x14 Gauge self tapping screws)	
Flush mounting screws (4 x 8 Gauge self tapping screws)	
Northstar wallet	
Contains the following items:	
<ul style="list-style-type: none"> • Flush mounting template 	
<ul style="list-style-type: none"> • LCD cleaning cloth 	
<ul style="list-style-type: none"> • Warranty card 	
<ul style="list-style-type: none"> • Quick start guide 	
<ul style="list-style-type: none"> • CD manual 	
<ul style="list-style-type: none"> • M121/M84 Installation and operation manual 	
<ul style="list-style-type: none"> • GPS 124 Antenna Installation and operation manual 	

20-2 Installation: Options and Accessories

- Replacement paddle wheel.
- C-MAP™ NT-MAX, NT+ or NT chart SD cards.
- Northstar NavBus junction boxes simplify wiring, particularly if several instruments are connected. For more information, see the *NavBus Installation Manual*.

Optional sensors and instruments

External alarms: Lights or sounders in the boat to sound alarms through the boat (see section 20-4).

GPS or DGPS antenna: For GPS navigation, see section 20-5.

Sonar transducer: For depth sounding and fish finding, see section 20-6.

Fuel sensors: For fuel functions. The Instrument can use these optional fuel flow sensors, fitted to one or two engines:

- Northstar petrol/gasoline sensors (see section 20-7)
- SmartCraft fuel sensors (see section 20-8)

DSC VHF radio: Tracks other boats with GPS receivers and DSC radios and displays barometric pressure (see section 20-10).

SmartCraft: With one or two SmartCraft capable Mercury petrol/gasoline engines, the Instrument can display engine data and trim and can control troll speed (see section 20-8).

Radar: For radar functions. A Northstar 2 kW, 4 kW or 6 kW radar system must be installed (see section 20-9).

Other instruments: The Instrument can receive data from other instruments and send data to other instruments by NavBus or NMEA (see sections 20-11 and 20-12).

Please consult your Northstar dealer for more information.

Connections

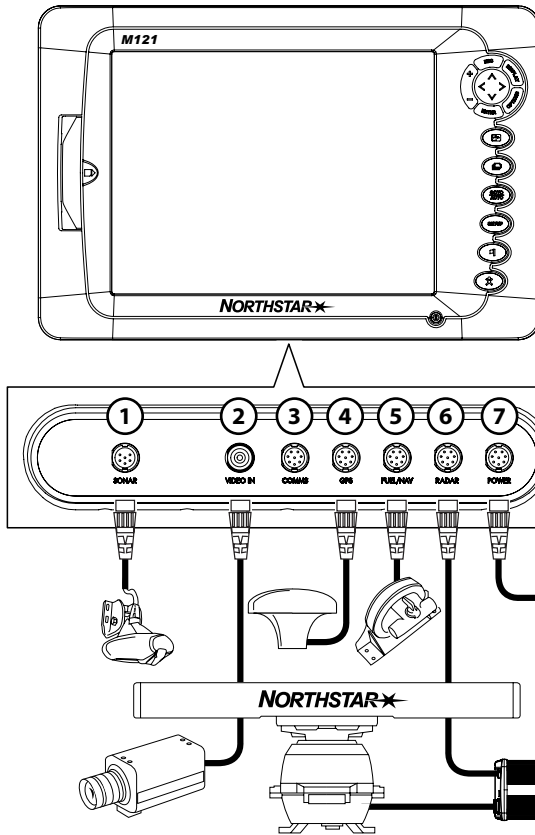

- | | | |
|---|-------------------------|--|
| ① | Sonar | Sonar Transducer |
| ② | Video in | Video Input
(Analogue composite [NTSC-PAL]) |
| ③ | Comms | Not Used |
| ④ | GPS | Northstar 124 GPS Antenna |
| ⑤ | Fuel/Nav | - Northstar Fuel TXD
- SmartCraft Gateway |
| ⑥ | Radar | Northstar Radar Processor |
| ⑦ | Power/data cable | |
- | Wire | Function |
|--------|--|
| Black | Ground: power negative, NMEA ground (Connect both black wires to ground) |
| Brown | Not Used |
| White | NMEA out |
| Blue | NavBus- |
| Red | Positive power in, 10 to 35 V DC |
| Orange | NavBus+ |
| Yellow | Auto power - Connect to red wire (positive power in) to enable Auto power No Auto power - Leave disconnected or connected to Black wire (ground) |
| Green | External Alarm output or light out, switches to ground during alarm condition, 200 mA maximum. |

20-3 Installation: The display unit

Start by selecting a suitable mounting position for the M121/M84 display unit:

- Consider the best possible position for viewing and operating the M121/M84. This will generally be a relatively shaded area free from obstructions.
- At least 4" (100 mm) away from the compass, at least 12" (300 mm) away from any radio transmitter and at least 4 ft (1.2 m) away from any antenna.
- For optimum performance and reliability consider mounting the unit where it will not be unnecessarily exposed to direct sunlight, water and protected from other physical damage which could occur during rough sea passages.
- If bracket mounting chose a flat area where the display will not be subjected excessive vibration.
- Select an area with adequate clearance for cabling and access to the power source.
- Before drilling any holes ensure that the drill area is free from cables or other obstructions.

There are two mounting arrangements:

Flush Mounting the M121/M84

1. Attach the flush mounting template to the selected mounting position using adhesive tape.
2. Drill a pilot hole for each of the hole saw cuts shown on the template before cutting the larger hole with the hole saw.
3. Next cut all the way around the inside of the cut-out line with a saw to remove the waste material shown on the template.
4. Check that the unit fits correctly in the cut out area. Adjust the fit with a file if required.
5. Select a 2-3.5 mm 1/8" drill bit depending on hardness of material to drill. Smaller diameter holes will be needed for soft woods and larger diameter pilot holes will be required if mounting to hard materials such as fiberglass (we recommend 3.5 mm (1/8") for fiberglass and Aluminum).
With the selected drill bit drill the 4 pilot holes for the 8 gauge screws used to attach the unit. These are indicated on the corners of the mounting template.
6. Connect all cables to the rear of the unit before placing the unit into the console.
7. Firmly secure the unit in place with the 4 x 8 gauge self tapping screws.

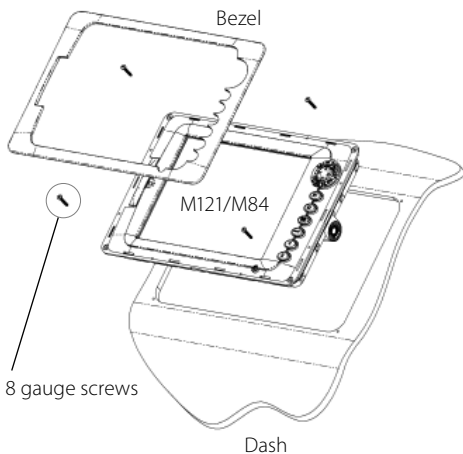

Note: the 5 x 14G self tapping screws are for bracket mounting only.

8. To finish off the installation firmly clip the front bezel in place.

Bracket Mounting the M121/M84

An alternative to flush mounting the M121/M84 is to bracket mount the unit. This method has the advantage that the display can be easily removed when it is not in use. The display may be tilted for best possible viewing angle when bracket mounted.

Note: The mounting bracket does not allow for rotation of the unit to the left and right.

1. Use the mounting bracket as a template to mark the 5 positions of the screw holes.
2. Select a suitable drill bit (note: larger diameter pilot holes may be required if mounting to fiberglass) and drill 5 pilot holes in the marked positions.
3. Secure the mounting bracket using the 5 x 14G self tapping screws.
4. Slide the M121/M84 into the mounting bracket and secure in place with the bracket knobs.
5. To finish off the installation firmly clip the front bezel in place.

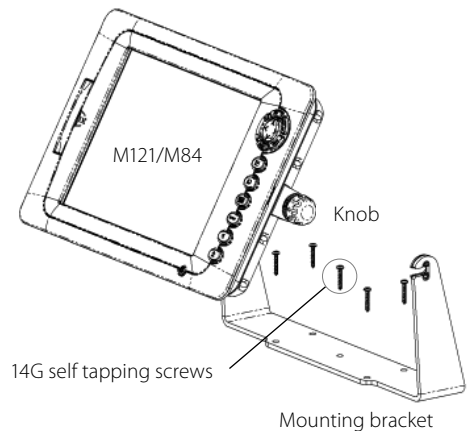

20-4 Installation: Power/data cable

The power/data cable has a black locking collar and flying leads.

- 1 Wire the Instrument for auto power to have the Instrument turn on with the boat's ignition switch or to record engine hours or if the Instrument must add up the total fuel used (for example if Northstar petrol/gasoline fuel sensors are installed or if SmartCraft is installed without fuel tank level sensors). Otherwise wire for basic power (for more information, see section 2-2).

Basic power

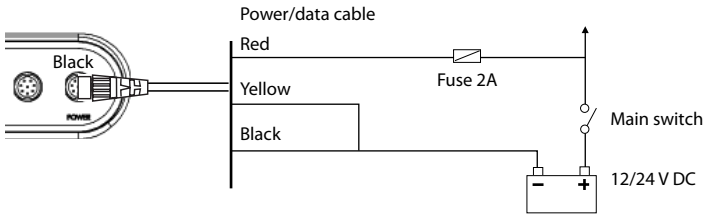

Auto power

When wired for Auto Power On the unit will turn on when the ignition switch is on, if you would like the unit to turn off when the ignition switch is off then set the unit for Auto Power Off (see section 2-2 and 17-1)

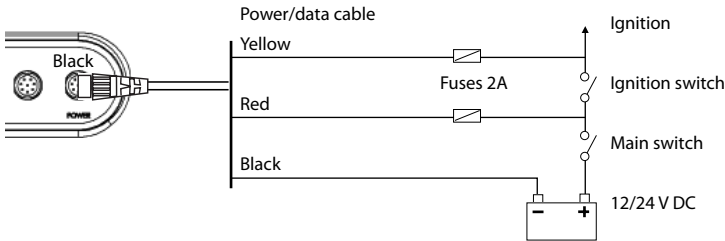

- 2 Wire any external alarm beepers or lights. The alarm output switches to ground to sound the alarm. If the current is more than 200 mA, fit a relay.
- 3 Connect the power/data cable to the black display unit connector; turn the collar to lock the connector.

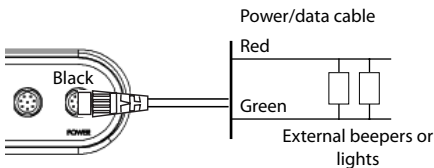

20-5 Installation: GPS antenna

Selecting an antenna

Fit one of these GPS antennas:

- Normally use the GPS antenna supplied.
- An optional differential beacon DGPS antenna to give enhanced accuracy within range of land based differential beacons in areas where WAAS or EGNOS are not available. Such a DGPS antenna has both a GPS receiver and a beacon receiver, and it automatically applies the beacon correction to the GPS position.
- A compatible GPS or DGPS instrument or antenna connected by NavBus (see section 20-10) or NMEA (see section 20-11). In this case, the Instrument does not need its own antenna.

Note:

- To configure the Instrument for different antenna options, see section 19-4.

For more information, contact your Northstar dealer.

DGPS Source:

Enables or disables the satellite based DGPS correction (see section 8). The options are **None** or **WAAS/EGNOS**. Do not Enable WAAS/EGNOS outside their coverage areas or the accuracy of the position might be degraded.

WAAS covers all of the USA and most of Canada. To use WAAS, the GPS antenna must have a clear view of the sky towards the equator. EGNOS will cover most of Western Europe.

Restart GPS:

Restarts the GPS receiver, satellite reception will be lost until the receiver completes its restart and acquires the satellites.

Select restart GPS and press .



MOB will not work if the Instrument does not have a GPS fix.

Installing an antenna

If an external antenna is required, install the antenna and fit the antenna cable back to the display unit. Follow the instructions in the manual supplied with the antenna. Fit an optional Northstar extension cable if required.

During setup, configure the Instrument for the chosen antenna, see section 19-4.

20-6 Installation: Sonar transducer

⚠ WARNING

Do not install plastic through hull transducers in solid wooden hulls. Leakage through the hull may result.

Do not install bronze transducers in metal hulls. This will cause electrolytic corrosion that may result in damage to the hull or transducer.

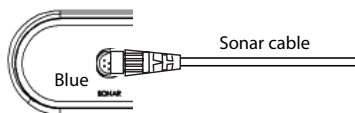

Connect the transducer to the blue Instrument connector; tighten the locking collar.

During setup

- set Sonar to (see section 19-1)
- set up the sonar options (see section 19-3)

20-7 Installation: Northstar petrol/gasoline sensors

Fit the optional petrol/gasoline fuel kit following the instructions supplied with the kit.

Note:

- SmartCraft engines have fuel flow sensors, therefore Northstar fuel sensors are not required as well.
- For dual engines, fit two kits.
- Wire the Instrument for auto power (see section 20-4).

During setup:

- set the fuel data (see section 19-6)

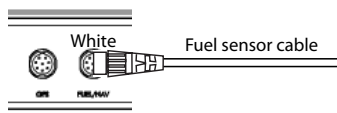

20-8 Installation: SmartCraft

If the boat has one or two SmartCraft capable Mercury petrol/gasoline engines, connect the Instrument to the SmartCraft engines with an optional SmartCraft gateway. The display unit can display engine data and trim and can control troll speed.

Note:

- Fit a single gateway for single engines and a dual gateway for dual engines.
- SmartCraft engines have fuel flow sensors, therefore Northstar fuel sensors are not required as well.
- If the fuel tank does not have SmartCraft level sensors, wire for auto power (see section 20-4).

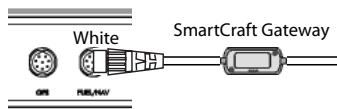

During setup enter the SmartCraft setup data. For information on installing, setting up and using SmartCraft, see the *SmartCraft Gateways Installation and Operation Manual*.

20-9 Installation: Radar

Install the Northstar radar as described in the Installation Manual supplied with the radar. Carefully read the important safety and warning information and also the location and wiring guidelines BEFORE installing the radar. Set up the radar as described in section 19-4.

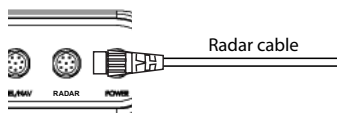

20-10 Installation: Other NavBus instruments

NavBus is Northstar's system for connecting instruments together to interchange data and share transducers. When instruments are connected by NavBus:

- If the units, alarms or calibration are changed in one instrument, then the values will automatically change in all other instruments of the same type.
- Each instrument can be assigned to a group of instruments. If the backlight is changed in an instrument in group 1, 2, 3 or 4 then the backlight will automatically change in the other instruments in the same group.
If the backlight is changed in an instrument in group 0 then no other instruments are affected.
- If an alarm sounds, mute it by clearing the alarm on any instrument which can display that alarm.

NavBus and the Instrument

The M121/M84 can:

- Display wind speed and direction from an optional Northstar Wind instrument
- Receive and display depth from an optional Northstar depth instrument.
- Receive and display boat speed and water temperature from a paddlewheel sensor on an optional Speed instrument.
- Receive data from an optional Northstar VHF radio (with NavBus functionality). The M121/M84 can display:

Baro: barometric pressure

Baro history: barometer history

Weather: a prediction, based on changes in barometric pressure

Fish forecaster: a prediction based on changes in barometric pressure

DSC/Buddy Track: (see section 17)

- Receive data from an optional GPS or GPS/DGPS source.
- Send data to optional Northstar instruments, for example to a repeater.

During setup for NavBus instruments, set NavBus to  and assign the instrument a NavBus group number (see section 19-12)

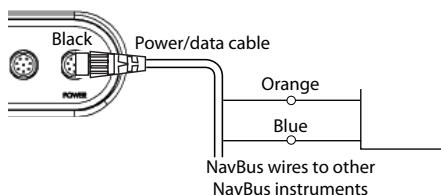

20-11-1 Installation: Northstar VHF radio

Fit and set up the optional Northstar VHF radio (with NavBus functionality) following the instructions supplied with the radio.

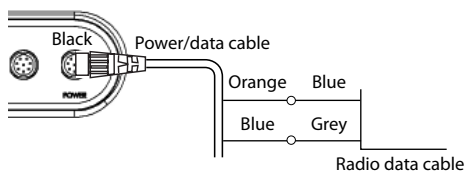

20-11 Installation: Other NMEA instruments

NMEA is an industry standard for interconnecting instruments. It is not as flexible or as easy to install as NavBus.

The Instrument can:

- Receive and display wind speed and direction from an optional compatible wind instrument.
- Receive and display depth, paddlewheel boat speed and water temperature from an optional compatible instrument.
- Receive data from an optional compatible GPS or DGPS source.
- Send GPS position and other navigation data to an autopilot or other instrument. An autopilot requires APB, APA and VTG sentences (see section 19-12).

For information on sending NMEA data to the Instrument, see your Northstar dealer.

During setup to send NMEA data to other instruments, set NMEA out to and specify the NMEA data to send (see section 19-12).

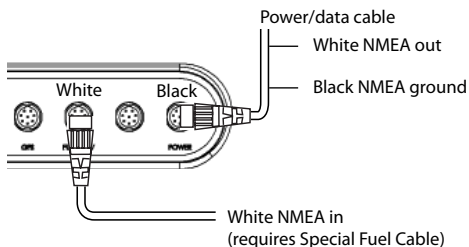

20-12 Installation: Setup and test

Setup and test

- 1 Put a blanking cap on any unused connector on the back of the display unit. Ensure all connectors are plugged in and the display unit is in place.
- 2 If the display unit is bracket mounted, adjust tilt and rotation for best viewing and hand tighten the knob.
- 3 Insert any required G-MAP chart card (see section 1-3).
- 4 Turn the instrument on (see section 2-2). When the Instrument is turned on for the first time, it displays an installation menu:
 - i Select the language to use.
 - ii Change the data if necessary (see section 2-1)
 - iii When the setup data is correct, press .This data can be changed later (see section 19).
- 5 Enter setup data to set up the Instrument to your requirements and to set up any optional sensors or instruments (see section 19).
- 6 At the satellite window, check that it picks up GPS satellites. Wait for the GPS receiver to start up and the fix type to change from 'Acquiring' to 'GPS fix'. This should take less than two minutes (see section 8).
- 7 Go on a test run to check that the navigation equipment works correctly, particularly when a radio transmitter or radar is used.

Appendix A - Specifications

GENERAL

M121 Size: 256 mm (10.08") H x 385 mm (15.16") W x 78.5 mm (3.09") D. Allow 3 mm clearance on each side for dust cover.

M84 Size: 190 mm (7.48") H x 285 mm (11.22") W x 76.8 mm (3.02") D. Allow 3 mm clearance on each side for dust cover.

M121 Display: 307 mm (12.1") diagonal, TFT color, 800 x 600 pixels.

M84 Display: 213.4 mm (8.4") diagonal, TFT color, 800 x 600 pixels.

Backlight: Display and keys

Supply voltage: 10.5 to 32 V DC.

Supply current: at 13.8 V

350 mA min - no backlighting.

1A max - full backlighting.

External beeper or light output: Switched to ground to sound alarm, 30 V DC, 200 mA maximum.

Operating temperature: 0° to 50°C (32° to 122°F)

ALARMS:

- User set: Arrival radius, anchor, XTE, danger, too shallow, too deep, fish, temperature, temperature rate, low battery, low fuel (optional), loss of DGPS fix, radar guard zone, dangerous AIS vessels.

GPS NAVIGATION

Chart card: C-MAP™ SD Card (NT-MAX, NT+ or NT)

User card: SD Card

Waypoints: Up to 3000, with default or user-defined alphanumeric names up to eight characters.

Routes: 25 Routes, with up to 50 points each

Tracks: By time or distance, one track of 2000 points and four of 500 points.

Chart datums

- 121 Chart datums (see next page)
- One user-defined map shift.

Chart scale: 0.05 to 4096 nm for chart (chart dependent) down to 0.01 nm in plotter mode.

SONAR FISHFINDING

(Optional sonar transducer required)

Depth range: 1 m (3 ft) to 1000 m (3300 ft)

Sonar output:

- Power: Variable, up to 600/1000 W RMS
- Dual frequency: 50 khz and 200 khz

Depth acquisition time from startup:

Typically 2 seconds at 30 m (100 ft)

Temperature:

- Range 0° to 37.7°C (32° to 99.9°F)
- Resolution of 0.1° unit.

Speed (from paddlewheel transducer):

1 to 96.6 kph (57.5 mph, 50 kn).

FUEL COMPUTER

(Optional fuel sensor(s) required)

Engine types:

- Outboard carburetted two stroke and EFI petrol/gasoline engines: 50 to 300 hp.
- Outboard four stroke petrol/gasoline engines: 90 to 300 hp.
- Inboard petrol/gasoline engines: 70 to 400 hp.

Flow rate:

- Minimum: 5 litres per hour (1.3 U.S. gallons per hr).
- Maximum: 130 litres per hour (34 U.S. gallons per hr).

COMMUNICATIONS

NavBus

Connection to other Northstar instruments.

NMEA: NMEA 0183 ver 2 4800 baud

- Inputs from compatible instruments: BWR, DPT, GGA, GLL, GSA, GSV, HDG, HDM, HDT, MTW, MWV, RMC, VHW, VTG and DBT
- Outputs, for compatible instruments: APA, APB, BWR, DBT, DPT, GGA, GLL, GSA, GSV, RMB, RMC, MTW, VHW, VLW, VTG, XTE

STANDARDS COMPLIANCE

EMC:

- USA: FCC Part 15 Class B.
- Europe: (CE) EN301843-1
- New Zealand and Australia: (C Tick) IEC60945

Environment: IPx6/IPx7/CFR46 (with card holder and connections in place)

Video

75Ω BNC Connector. Most PAL and NTSC formats supported. (PAL BGHI, PAL N, Combination PAL N, PAL M, NTSC M, NTSC N, NTSC 4.43, NTSC-Japan and SECAM)

Physical Dimensions

Northstar M121

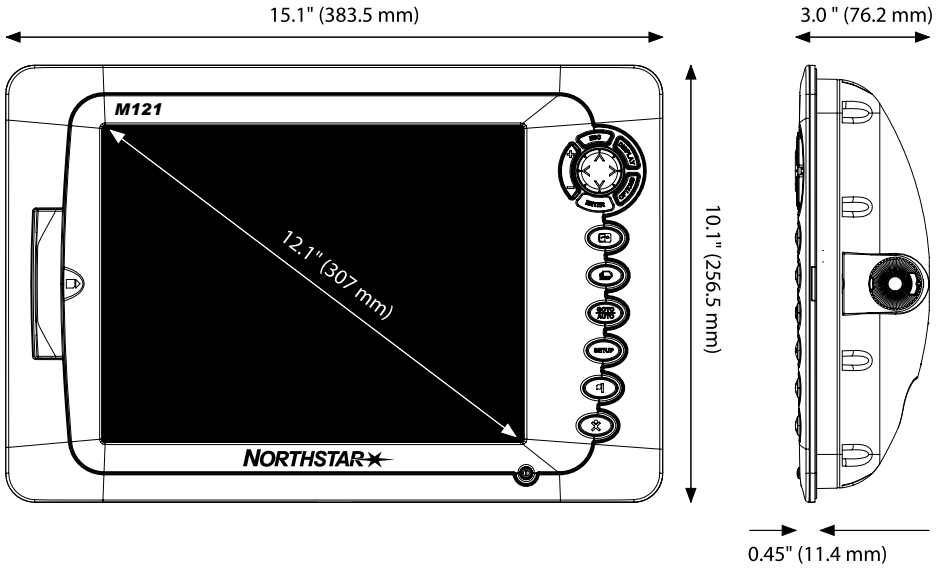

Northstar M84

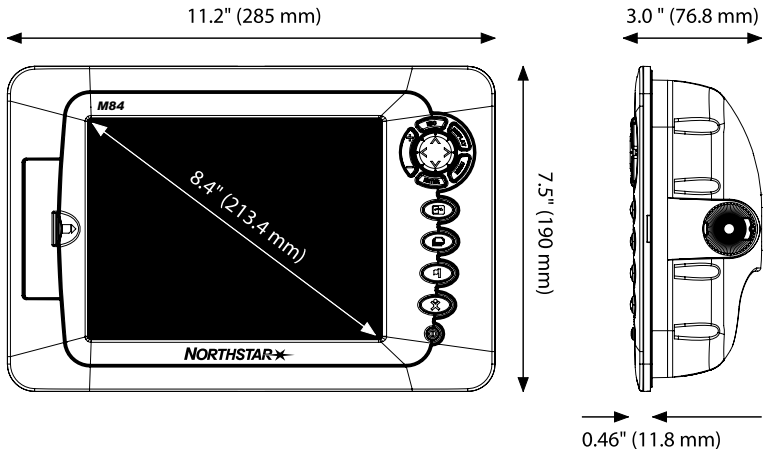

List of datums

Adindan	Afgooye	AIN EL ABD 1970
American Samoa 1962	Anna 1 Astro 1965	Antigua Island Astro 1943
ARC 1950	ARC 1960	Ascension Island 1958
Astro Beacon 'E' 1945	Astro DOS 71/4	Astro Station 1952
Astro Tern Island (Frig) 1961	Australian Geodetic 1966	Australian Geodetic 1984
Ayabelle Lighthouse	Bellevue (IGN)	Bermuda 1957
Bissau	Bogota Observatory	Bukit Rimpah
Camp Area Astro	Campo Inchauspe 1969	Canton Astro 1966
Cape	Cape Canaveral	Carthage
Chatham Island Astro 1971	Chua Astro	Co-ord. Sys.1937 Estonia
Corrego Alegre	Dabola	Deception Island
Djakarta (Batavia)	DOS 1968	Easter Island 1967
European 1950	European 1979	Fort Thomas 1955
Gan 1970	Geodetic Datum 1949	Graciosa Base Sw 1948
Guam 1963	Gunung Segara	GUX 1 Astro
Herat North	Hermannskogel	Hjorsey 1955
Hong Kong 1963	Hu-Tzu-Shan	Indian
Indian 1954	Indian 1960	Indian 1975
Indonesian 1974	Ireland 1965	ISTS 061 Astro 1968
ISTS 073 Astro 1969	Johnston Island 1961	Kandawala
Kerguelen Island 1949	Kertau 1948	Kusaie Astro 1951
L. C. 5 Astro 1961	Leigon	Liberia 1964
Luzon	M'Poraloko	Mahe 1971
Massawa	Merchich	Midway Astro 1961
Minna	Montserrat Island Astro 1958	Nahrwan Masirah Is. Oman
Nahrwan United Arab Emirates	Nahrwan Saudi Arabia	Naparima, BWI
North American 1927	North American 1983	North Sahara 1959
Observatorio Meteorolog. 1939	Old Egyptian 1907	Old Hawaiian
Oman	Ord. Survey Great Britain 1936	Pico de las Nieves
Pitcairn Astro 1967	Point 58	Pointe Noire 1948
Porto Santo 1936	Provis. South American 1956	Provis. South Chilean 1963
Puerto Rico	Pulkovo 1942	Qatar National
Qornoq	Reunion	Rome 1940
S-42 (Pulkovo 1942)	Santo (DOS) 1965	Sao Braz
Sapper Hill 1943	Schwarzeck	Selvagem Grande 1938
Sierra Leone 1960	S-JTSK	South American 1969
South Asia	Tananarive Observatory 1925	Timbalai 1948
Tokyo	Tristan Astro 1968	Viti Levu 1916
Voirol 1874	Voirol 1960	Wake Island Astro 1952
Wake-Eniwetok 1960	WGS 84	Yacare
Zanderij		

Appendix B - Troubleshooting

This troubleshooting guide is written with the assumption that the user has read and understood the relevant sections in this manual. It is possible in many cases to solve difficulties without having to send the display unit back to the manufacturer for repair. Please follow this troubleshooting section before contacting the nearest Northstar dealer.

There are no user serviceable parts. Specialized methods and testing equipment are required to ensure that the display unit is reassembled correctly and is waterproof. Users who service the product themselves will void the warranty.

Repairs to the product may only be carried out by a service centre approved by Northstar. If the product must be sent into a service centre for repair, it is essential to send in the transducer(s) at the same time.

More information can be found on our Website: www.northstarnav.com.

B-1 General problems

1-1 The Instrument won't turn on:

- a The Instrument is designed to operate on a 12/24 volt battery system, where the voltage may vary from 10.5 to 32 volts. If an excessive voltage is supplied, a fuse will be tripped, turning the display unit off. Check the fuse.
- b Check that the power cable connector at the back of the display unit is securely plugged in and the collar is locked in place. The collar must be secure for watertight connection.
- c Measure the battery voltage while the battery is under load - turn on some lights, radio or other electrical equipment connected to the battery. If the voltage is less than 12 volts:
 - the battery terminals or wiring on the terminals may be corroded.
 - the battery may not be charging correctly or may need replacing.
- d Inspect the power cable from end to end for damage such as cuts, breaks, squashed or trapped sections.
- e Check power wiring (see section 18-4).

- f Check for corrosion on the power cable connector and clean or replace if required.
- g Check fuses that are placed in line with the power cable. A fuse can be blown despite appearing to be good or the fuse may be corroded. Test the fuse or replace it with a fuse known to be good.

1-2 The Instrument won't turn off:

The Instrument may have been wired for Auto power. In this case, the Instrument cannot be turned off while the ignition power is on (see section 2-2).

1-3 If the Instrument beeps when turned on but nothing is displayed:

The Instrument may be operating, but the backlight settings may have been set too low (see section 2-3).

1-4 The wrong language is displayed:

See section 19-1.

B-2 GPS navigation problems

2-1 No GPS fix or long time to get fix at startup:

- a May occur occasionally if the antenna does not have a clear view of the sky. The satellite positions are constantly changing.
- b Antenna cable not connected to display unit.

2-2 Instrument GPS position different from true position by more than 10 m (33 ft):

- a Instrument in simulate mode. Turn simulate mode off (see section 19-16).
- b The normal error in GPS position will exceed 10 m (33 ft) for about 5% of the time.
- c Under special circumstances the US Department of Defence may introduce a deliberate and changing error in the GPS positions of up to 300 m (1000 ft).

2-3 Instrument position different from same position on local charts:

- a Instrument in simulate mode. Turn simulate mode off (see section 19-16).
- b Incorrect chart datum. Select the correct chart datum (see section 19-2).
- c Map shift has been applied wrongly. Clear map shift, then reapply if necessary (see section 19-2).

2-4 Can not see boat on chart:

- Press **ESC** to switch to centre on boat mode (see section 3-2-1).

2-5 The time or date on satellite display is wrong or off:

- a No GPS fix.
- b In simulate mode. Turn simulate mode off (see section 19-16).
- c Local time offset is wrong (see section 17-12). The Local Time Offset must be changed when daylight saving time starts or ends.

2-6 Autopilot not responding to Instrument; no NMEA output:

- a NMEA output disabled or the required NMEA sentences are not turned on. Check NMEA settings (see section 19-12).
- b Check that the instrument is connected correctly.

2-7 No DGPS fix or loss of DGPS fix:

- a To receive a DGPS fix, WAAS/EGNOS must be enabled or an optional DGPS antenna fitted (see section 8).
- b With WAAS/EGNOS: Boat out of coverage area (see section 8).
- c With WAAS: GPS antenna does not have a clear view of the horizon towards the equator.
- b With beacon DGPS: boat out of range of a DGPS beacon.

B-3 Fuel consumption problems

3-1 Fuel used or remaining seem inaccurate:

- a Instrument is not wired for auto power (see section 20-4).
- b In rough seas, fuel may surge back and forth through the fuel transducer, resulting in incorrect readings. Try installing a one-way valve between the fuel transducer and the fuel tank.
- c The `Set remaining` fuel value must be reset after every refuelling (see section 113-1).
- d The fuel tank may not refill to the same capacity each time due to air pockets. This is particularly noticable with underfloor tanks.
- e Fuel transducers wear out over time and should be replaced after every 5000 litres of fuel.

3-2 Flow indicates no fuel or low fuel:

- a Check that the number of engines is set to 1 (see section 19-6).
- b Check that the fuel cable connectors are securely plugged in and the collar is locked in place. The collar must be locked in place to give a watertight connection.
- c A fuel transducer may be clogged. If so, remove the transducer from the fuel line and gently blow through it in the opposite direction to the fuel flow.
A fuel filter between the fuel transducer and the fuel tank must be installed as per the fuel installation guide. Failure to do so will void the warranty.
- d Inspect the fuel cable from end to end for damage such as cuts, breaks, trapped or squashed sections.
- e Check that the fuel filter is clean.

3-3 A twin engine installation shows only one flow rate:

- a Check that the number of engines is set to 2 (see section 19-6).

3-4 Erratic Fuel Flow readings:

- a The fuel flow transducer may have been mounted too close to the fuel pump or may be subject to excessive vibration. Refer to the installation instructions supplied with the fuel transducer.
- b Check for leaks in the fuel line or in the fuel pickup in the tank.
- c The **Flow filter** value is not suitable for the engine. Check that the value is not set to zero, then try increasing the value until a steady flow rate is shown (see section 19-6).

3-5 There is no reading for fuel economy:

- a The boat must be travelling through the water to generate an **Economy** reading.
- b Check that the paddlewheel on the transducer is spinning freely and that the two magnets in the paddlewheel are still in place.

B-4 Sonar fishfinding problems

4-1 The Instrument operates erratically:

- a Check that the transducer does not have debris (e.g. weed, plastic bag) caught around it.
- b The transducer may have been damaged during launching, running aground or while underway with debris etc. If the transducer has been impacted, it may have been kicked up on the bracket. If it is not physically damaged, reset the transducer back to its original position. (See the *Transom Transducer Installation Guide*.)
- c When the transducer is less than 2 ft (0.6 m) from the bottom, the depth readings may become inconsistent and erratic.
- d Manual Gain may be set too low, which may cause weak bottom echo or no fish signals. If in Manual Gain, try increasing the Gain.
- e Ensure the back of the bottom surface of the transducer is slightly lower than the front and the front is as deep in the water as possible in order to minimize the generation of bubbles through cavitation. (See the *Transom Transducers Installation Guide*)
- f Check the transducer and power cable connectors at the back of the display unit are securely plugged in and the collars are locked in place. The collars must be secure for watertight connection.
- g Inspect the power cable from end to end for damage such as cuts, breaks, squashed or trapped sections.
- h Ensure there is not another fishfinder or depth sounder turned on, which may interfere with this Instrument.

- i Electrical noise from the boat's engine or an accessory may be interfering with the transducer(s) and/or the Instrument. This may cause the Instrument to automatically decrease the Gain unless using Manual Gain. The Instrument thus eliminates weaker signals such as fish or even the bottom from the display. This may be checked by switching off other instruments, accessories (e.g. bilge pump) and the motor until the offending device is located. To stop problems from electrical noise, try:
 - re-routing the power and transducer cable(s) away from the boat's other electrical wiring.
 - routing the display unit's power cable directly to the battery with an in-line fuse.

4-2 Bottom is not displayed:

- a The Instrument may have Manual Range selected and the depth may be outside the range value selected. Either change the Instrument to Auto Range or select another depth range (see section 8-5).
- b The depth may be outside the Instrument's range. While in Auto Range, the display unit will display "--:" to indicate that there is no bottom detected. A display of the bottom should reappear when in shallower water.

4-3 The bottom is displayed too far up the screen:

The Instrument may have Manual Range selected and the selected Range value is too high for the depth. Either change the Instrument to Auto Range or select another depth range (see section 8-5)

4-4 Bottom echo disappears or erratic digital reading while the boat is moving:

- a Ensure the back of the bottom surface of the transducer is slightly lower than the front and the front is as deep in the water as possible in order to minimise the generation of bubbles through cavitation. (See the *Transom Transducers Installation Guide*, for more information.)
- b The transducer may be in turbulent water. Air bubbles in the water disrupt the echoes returned, interfering with the Instrument's ability to find the bottom or other targets. This often happens when the boat is reversed. The transducer must be mounted in a smooth flow of water in order for the Instrument to work at all boat speeds.
- c Electrical noise from the boat's motor can interfere with the Instrument. Try some suppression spark plugs.

4-5 There is a double bottom trace displayed:

- a The boat may be in an area that generates shadows (see section 9-2).
- b In shallow water, the echoes may bounce. Reduce the gain setting (see section 9-6) and/or reduce the sonar pulse power (see section 19-3).
- c Decrease the Range.

B-5 Radar problems

5-1 Radar overlay doesn't appear on the chart screen

- a Ensure that your boat is shown on the radar window. If it is, but the radar overlay still isn't shown, try zooming in on the charted area. (The charted area may be outside the maximum range of the radar).
- b The threshold or transparency settings for the radar overlay are not correct (see 18-6).

5-2 Radar shows arcs and/or shadows

Side lobe patterns often appear as an arc or a broken arc. Shadows are blind spots.

If the radar is installed at a suitable height and in a suitable location on your boat, side lobe patterns and shadows caused by obstructions such as funnels or masts will be minimized.

If you are having problems with these, you may need to relocate your radar. Consult the Installation Guide for your radar model for advice.

5-3 Radar shows different patterns on each sweep

Interference patterns always appear in a different place with each sweep. They can be randomly scattered bright dots or dotted lines that extend from the centre to the edge of the radar window, often producing a spiral effect. Generally, the stronger the interference, the wider the interference lines.

- a Use the interference rejection feature to reduce interference patterns, and the width of the interference lines (see 19-4).

5-4 Radar shows false echoes and/or background noise

False echoes and/or background noise can be produced if the radar sensitivity is too high.

- a Try using the Auto setting for the radar gain mode (see 19-4). If this doesn't work, or if the radar gain mode is already set to Auto, use the radar gain setting to reduce the radar sensitivity

5-6 Radar shows multiple echoes off the same object

Multiple echoes off the same object are most likely to occur when you are close to a large target, and are usually only a temporary nuisance.

5-7 Radar shows random or grouped dots

Rain clutter often appears as random dots that can merge into badly-defined echoes on the radar window. The random signals are returned from rain, hail, sleet, or snow and can result in a confusing display

5-8 Radar shows random signals in centre

Sea clutter usually appears as confusing, random signals around your boat. High waves will produce the maximum amount of sea clutter.

You can optimize your radar window to reduce the effects of sea clutter (see section 18-6-4).

Appendix C Glossary and navigation data

Air temp - Air temperature (requires Northstar 721 VHF radio).

Alarm status - Shows the symbol (see section 19-10) for each alarm that is on. The symbol is normally black and turns red if the alarm triggers.

Attention Area - An important area on a chart, such as a restricted anchorage or a shallow area (see section 19-2).

AIS - Automatic Identification System. A System where vessel information (location, course, speed, etc.) is broadcast by VHF radio, for use by other vessels in navigation and collision avoidance.

Bathymetric line - A depth contour line on the chart.

Chart card - A plug-in card that stores chart data for a region (see section 1-3).

C-MAP™ chart card - See Chart card.

C-MAP™ user card - See User card.

CPA - Closest Point of Approach. The closest distance two vessels will come to each other based on their current course and speed.

Cursor - A \oplus symbol on the display (see section 3-2).

DGPS - Differential Global Positioning System. A navigation tool based on GPS with some errors corrected (see section 7).

DSC - Digital Selective Calling. A feature of marine radios enabling communication between specific vessels, as well as distress alerts.

DTN - Distance to the next position the M121/M84 is navigating to, either a waypoint or the cursor.

Fish forecaster - An estimate of the likelihood of catching fish based on barometric pressure. The more fishes that show the higher the likelihood (requires Northstar 721 VHF radio).

Gear - The gear the engine is in (requires SmartCraft).

Goto - A simple way of navigating straight to a waypoint or to the cursor position (see section 3-1).

GPS - Global Positioning System. A satellite-based navigation tool (see section 7).

Leg - The straight segments of a route between waypoints. A route with four waypoints has three legs.

MMSI - Maritime Mobile Service Identity. Unique identification number for a vessel, for use in Digital Selective Calling.

MOB - Man overboard.

MOB function - Starts navigating back to the place where someone fell overboard (see section 2-4).

NavBus - A way of connecting Northstar instruments together to share data (see section 20-10).

NMEA - National Marine Electronics Association.

NMEA 0183 - A standard for interfacing marine electronic devices (see section 20-11).

Radar guard zone - An area around the boat, set up by the operator and defined by distance and bearing. If an object (e.g. another boat) enters the radar guard zone, an alarm is activated.

Rain clutter - Heavy rain or snow can cause interference with the radar image.

Range (radar) - The distance between the centre of the radar image and the outer range ring. The scale is shown in the top left corner of the radar window.

Range rings - Concentric circles extending from your boat (usually at the centre of the radar window) and used to estimate distances to objects. The scale is shown in the top left corner of the radar window.

Route - Two or more waypoints linked in sequence to form a course for the boat (see section 7).

SmartCraft - A feature of Mercury Marine engines for monitoring engine performance.

TCPA - Time to Closest Point of Approach. Time until the closest point of approach for two vessels.

Sea clutter - Rough seas can cause interference with the radar image.

Sonar status - A summary of sonar settings.

TTN - Time to the next position the M121/M84 is navigating to, either a waypoint or the cursor.

User card - A plug-in card that stores waypoints, routes and tracks (see section 1-2).

UTC - Universal Time Coordinated or Coordinated Universal Time, which is a standard world time, formerly called Greenwich Mean Time (GMT).

VHF - Very High Frequency. The frequency range used by marine radios.

Waypoint - A position that you can set on the Instrument chart, for example a fishing spot or a point on a route (see section 5).

Weather - An estimate of the weather based on barometric pressure (requires Northstar 721 VHF radio).

Navigation data

- BRG** Bearing to Destination: Bearing to the destination from the boat.
- ↕BRG** Bearing to cursor: Bearing to cursor from boat (cursor mode, see section 3-2-1)
- CDI** Course Deviation Indicator: When the boat is navigating to a point, the chart and highway windows show a parallel line on either side of the plotted course. These two lines are called the Course Deviation Indicator (CDI) lines. The distance from the plotted course to a CDI line is the CDI scale.
- Set the CDI scale (see section 17-2) to the maximum distance that the boat should deviate from the plotted course. The chart and highway windows show the CDI lines, which are like a highway over the water where the boat will move. The windows show how far the boat has deviated from the plotted course and if the boat is approaching a CDI line. If the XTE alarm is enabled (see section 17-8) an alarm will sound if the boat reaches a CDI line.
- COG** Course Over Ground: Direction in which the boat is moving over the ground.
- CTS** Course To Steer: Optimum course to steer to return to the plotted course.
- DTG** Distance To Go: Distance from the boat to the destination.
- ETA** Expected Time of Arrival: At the destination, assuming that SOG and COG remain constant.
- ↕DST** Distance from boat to cursor (cursor mode, see section 3-2)
- SOG** Speed Over Ground: Current boat speed over the ground. This is not necessarily the same as the boat speed through the water nor the speed at which it is approaching the destination.
- STR** Steering: The difference between COG and CTS.
- TTG** Time To Go: The estimated time to reach the destination.
- XTE** Cross Track Error: The distance from the boat to the nearest point of the plotted course. XTE may have a letter: R means steer to the right to return to the plotted course, L means steer to the left.
- VMG** Velocity Made Good: The speed at which the boat is approaching the destination.

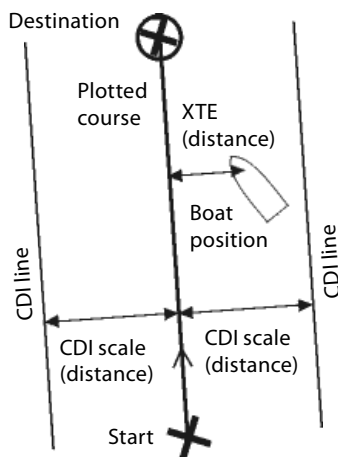
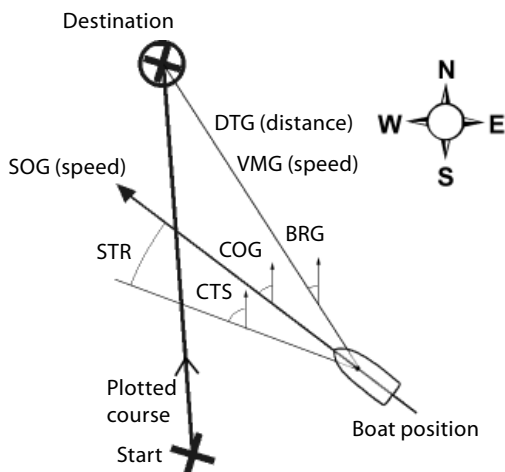

Appendix D Compliance statements

FCC Statement

Note: This equipment has been tested and found to comply with the limits for a Class B digital device, pursuant to Part 15 of the FCC Rules. These limits are designed to provide reasonable protection against harmful interference in a normal installation. This equipment generates, uses and can radiate radio frequency energy and, if not installed and used in accordance with the instructions, may cause harmful interference to radio communications. However, there is no guarantee that interference will not occur in a particular installation. If this equipment does cause harmful interference to radio or television reception, which can be determined by turning the equipment off and on, the user is encouraged to try to correct the interference by one or more of the following measures:

- Reorient or relocate the receiving antenna.
- Increase the separation between the equipment and receiver.
- Connect the equipment into an output on a circuit different from that to which the receiver is connected.
- Consult the dealer or an experienced technician for help.
- A shielded cable must be used when connecting a peripheral to the serial ports.

Industry Canada

Operation is subject to the following two conditions (1) this device may not cause interference, and (2) this device must accept any interference, including interference that may cause undesired operation of the device.

Hereby, Northstar New Zealand, declares that this M121/M84 is in compliance with the essential requirements and other relevant provisions of Directive 1999/5/EC.

AMERICAS

30 Sudbury Road,
Acton, MA 01720, USA

Ph: +1 978.897.6600

Ph: +1 800.628.4487

Fax: +1 978.897.7241

sales@bntmarine.com

EUROPE

Unit 2, Ocean Quay,
Belvidere Rd, Southampton,

SO14 5QY, ENGLAND

Ph: +44 2380 339922

Fax: +44 2380 330345

northstaruk@northstarnav.com

AUSTRALIA

PO Box 479,
Gladesville, NSW 2111,

AUSTRALIA

Ph: +61 2 9879 9060

Fax: +61 2 9879 9009

northstaraus@northstarnav.com

NEW ZEALAND

PO Box 68 155,
Newton, Auckland

Auckland, NEW ZEALAND

Ph: +64 9 481 0500

Fax: +64 9 481 0590

northstarnz@northstarnav.com

www.northstarnav.com

NORTHSTAR 



Made in New Zealand
MN000638A-G